



ALMECO

air and water technologies



ADK

Short case fan



Our solutions

Almeco is a reliable partner for fans, drying systems and cooling towers. With our customer, we look for the most efficient solution, either a standard or a custom product. Moreover, we provide service and maintenance on existing products. Almeco is a specialist in water cooling towers: both delivering new towers as revamping, maintenance and water treatment. We also produce and distribute various types of industrial fans. Finally, Almeco develops drying solutions based on air knife technology to suit client specific requirements. Engineering and design are done with constant striving for safety and quality improvement.

Industrial fans and blowers

We offer a wide range of industrial fans and blowers: from small axial and centrifugal fans for standard applications to large custom made fans adapted to usage in the most demanding circumstances. Our range of products consists of axial and centrifugal fans, blowers, roof fans and ATEX fans.

Service for industrial fans

- Balancing
- Vibration measurement and analysis
- Sound measurement
- Replacement of spare parts, complete impellers or fans and accessories
- Maintenance and reparation, on-site or in our workspace
- Optimization of fans
- Upgrades

Almeco nv/sa

Rue de la Royenne 51
B-7700 Mouscron

T: +32 (0)56 85 40 80

F: +32 (0)56 85 40 81

info@almeco.eu

www.almeco.eu



ALMECO

air and water technologies



ErP directive for energy efficiency

The industrial fans produced by Almecco are designed to meet the **European ErP directive** (Ecodesign) for energy efficient fans. On their **optimum energy efficiency point** the fans - with a power input between 125 W and 500 kW - gain the **energy efficiency**, as stated by Regulation 327/2011.



Industrial fans consume about **20% of the total industrial powerconsumption** or a total consumption of 275 TWh. By the year **2020** the European Union aims a **global saving in electricity of 34 TWh**.

The **minimum energy efficiency** that industrial fans must meet, are dependent on:

- The type of fan: axial, centrifugal with backwards inclined blades...
- Measurement category (A, B, C, D): defines the inlet and outlet conditions of the fan under test
- Operation with or without frequency converters

This information is also mentioned on the type plate of the fan.

Timing for application of the ErP directive

2005: EuP directive (Energy-using Products Directive) is issued

2009: EuP directive is renamed as "ErP directive". Research into the potential savings of certain product categories is launched.

2011: Directive 640/2009: new efficiency classes for motors

2013: Directive 327-2011: new efficiency classes for fans
First phase of implementation: efficiency requirements for fans are obligatory (depending on category and type)

2015: Second phase of implementation with stricter requirements

2017: Third phase of implementation of which the requirements are even more strict

Content

p. 5-29 **ADK fans**

p. 30-34 **Accessories**



ADK

Short case fan

Characteristics

- Axial fan with welded steel casing
- Fan casing, hot dip galvanized after manufacturing
- Asynchronous 3-phased multi-voltage motor 230/400V 50Hz (if <5.5kW) or 400/690V (if >= 5.5kW)
- Impeller with glass-reinforced nylon blades
- Standard cast aluminium hub and IEC central boring, with key way

Drawing and dimensions

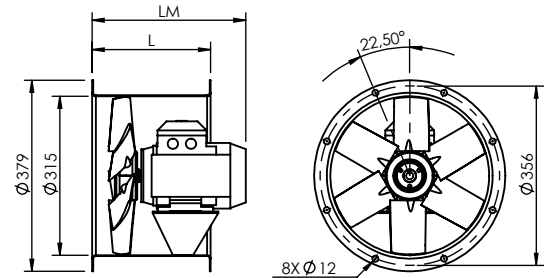

Special configurations

- Dimensions (fan diameter, flanges, casing length, ...) according to customer's requirements
- Stainless steel casing
- ATEX execution for zone 1/21 and/or zone 2/22
- Cast aluminium blades
- Single-phase motor (up to 2.2kW, 2 and 4 poles)
- Hydraulic motor
- Special executions on demand

Motor, noise and ErP data according to EU 327/2011

Curve N(#)	N-P	Type	Pitch (°)	Power (kW)	Speed (RPM)	IE	L (mm)	LM (mm)	Weight (kg)	eff _o (%)	eff target (%)	P _{in1} (kW)	V _{opt1} (m³/h)	P _{opt1} (Pa)	Article code
1	3-6	P3H	25	0,18	2820	IE2	235	283	10	37,50	29,50	0,20	1776	187	A1.000.257
2	3-6	P3H	30	0,25	2810	IE2	235	283	11	37,70	30,10	0,30	2050	199	A1.000.258
3	3-6	P3H	35	0,37	2800	IE2	235	305	11	32,80	31,00	0,40	2354	213	A1.000.259
4	6-6	P3H	25	0,37	2800	IE2	235	305	12	35,30	31,00	0,40	2047	257	A1.000.260
5	6-6	P3H	30	0,55	2790	IE2	235	305	13	35,10	31,60	0,50	2422	273	A1.000.261
6	6-6	P3H	35	0,55	2790	IE2	235	305	13	33,70	32,30	0,60	2876	287	A1.000.262

N-P: number of blades - available positions

LM: indicative

eff_o: efficiency on optimal point (aerolic efficiency x motor efficiency)

All data concerning efficiency is given for working without frequency inverter and based on installation mode A - Static

V_{opt1}: Volume flow on optimal point

P_{opt1}: Pressure on optimal point

The specific ratio for all fans is ~1,00

P_{in1}: Electrical active power at max. efficiency working point

In case of empty cells: ErP non applicable if power < 125W

Curves

Static pressure (p) [Pa]

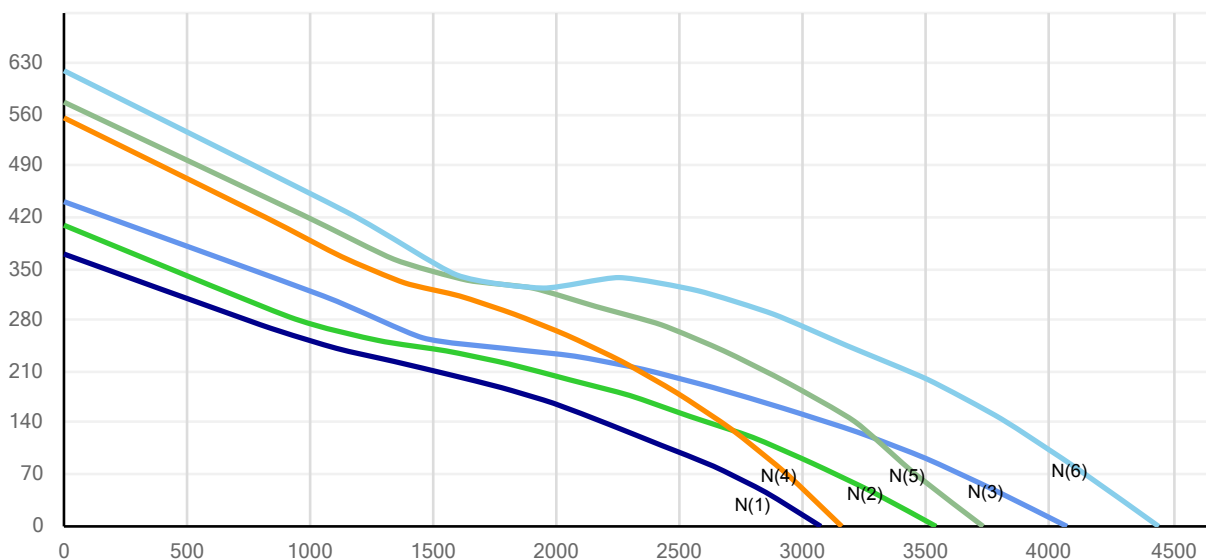

Air flow (Q) [m³/h]

Characteristics

- Axial fan with welded steel casing
- Fan casing, hot dip galvanized after manufacturing
- Asynchronous 3-phased multi-voltage motor 230/400V 50Hz (if <5.5kW) or 400/690V (if >= 5.5kW)
- Impeller with glass-reinforced nylon blades
- Standard cast aluminium hub and IEC central boring, with key way

Drawing and dimensions

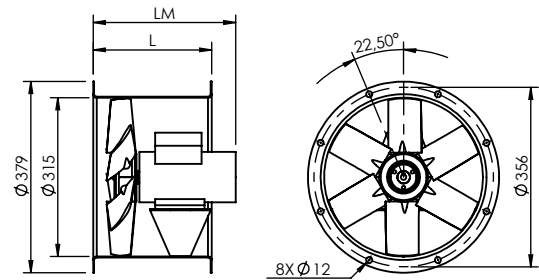

Special configurations

- Dimensions (fan diameter, flanges, casing length, ...) according to customer's requirements
- Stainless steel casing
- ATEX execution for zone 1/21 and/or zone 2/22
- Cast aluminium blades
- Single-phase motor (up to 2.2kW, 2 and 4 poles)
- Hydraulic motor
- Special executions on demand

Motor, noise and ErP data according to EU 327/2011

Curve N(#)	N-P	Type	Pitch (°)	Power (kW)	Speed (RPM)	IE	L (mm)	LM (mm)	Weight (kg)	eff _o (%)	eff target (%)	P _{in1} (kW)	V _{opt1} (m³/h)	P _{opt1} (Pa)	Article code
1	3-6	P3H	25	0,12	1400	IE2	235	283	10						A1.000.263
2	6-6	P3H	25	0,12	1400	IE2	235	283	11						A1.000.264
3	6-6	P3H	30	0,12	1400	IE2	235	283	11						A1.000.265
4	6-6	P3H	35	0,12	1400	IE2	235	283	11						A1.000.266
5	6-6	P3H	40	0,12	1400	IE2	235	283	11						A1.000.267
6	10-10	P3H	35	0,12	1400	IE2	235	283	11						A1.000.268
7	12-12	P3H	40	0,12	1400	IE2	235	283	11						A1.000.269
8	12-12	P3H	45	0,12	1400	IE2	235	283	11						A1.000.270

N-P: number of blades - available positions

LM: indicative

eff_o: efficiency on optimal point (aerolic efficiency x motor efficiency)

All data concerning efficiency is given for working without frequency inverter and based on installation mode A - Static

V_{opt}: Volume flow on optimal point

P_{opt}: Pressure on optimal point

The specific ratio for all fans is ~1,00

P_{in}: Electrical active power at max. efficiency working point

In case of empty cells: ErP non applicable if power < 125W

Curves

Static pressure (p) [Pa]

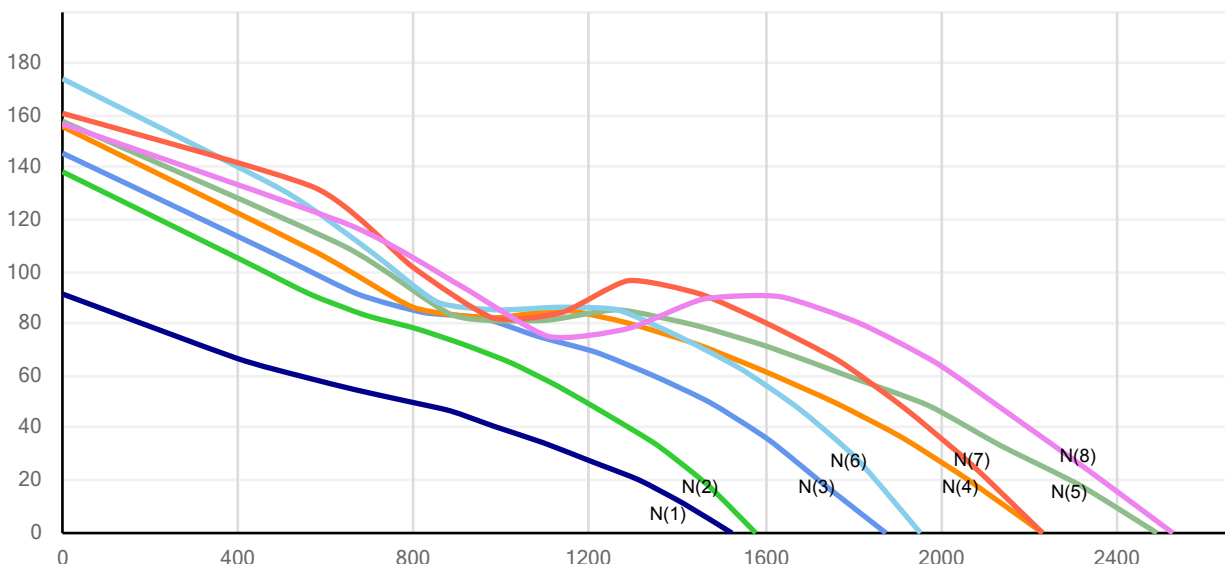

Air flow (Q) [m³/h]

This information can be incorrect due to mistakes and may be changed at any time without prior notice.

Characteristics

- Axial fan with welded steel casing
- Fan casing, hot dip galvanized after manufacturing
- Asynchronous 3-phased multi-voltage motor 230/400V 50Hz (if <5.5kW) or 400/690V (if >= 5.5kW)
- Impeller with glass-reinforced nylon blades
- Standard cast aluminium hub and IEC central boring, with key way

Drawing and dimensions

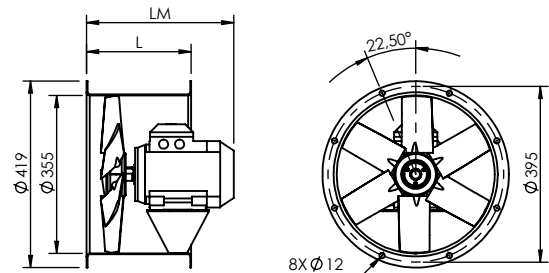

Special configurations

- Dimensions (fan diameter, flanges, casing length, ...) according to customer's requirements
- Stainless steel casing
- ATEX execution for zone 1/21 and/or zone 2/22
- Cast aluminium blades
- Single-phase motor (up to 2.2kW, 2 and 4 poles)
- Hydraulic motor
- Special executions on demand

Motor, noise and ErP data according to EU 327/2011

Curve N(#)	N-P	Type	Pitch (°)	Power (kW)	Speed (RPM)	IE	L (mm)	LM (mm)	Weight (kg)	eff _g (%)	eff target (%)	P _{in1} (kW)	V _{opt1} (m³/h)	P _{opt1} (Pa)	Article code
1	3-6	P3H	25	0,25	2810	IE2	235	283	12	41,00	30,30	0,30	2377	205	A1.000.271
2	3-6	P3H	30	0,37	2800	IE2	235	305	12	36,70	31,30	0,40	2765	221	A1.000.272
3	3-6	P3H	35	0,55	2790	IE2	235	305	13	36,40	31,90	0,50	3221	241	A1.000.273
4	3-6	P3H	40	0,55	2790	IE2	235	305	13	33,40	32,50	0,60	3523	246	A1.000.274
5	6-6	P3H	25	0,55	2790	IE2	235	305	13	39,00	31,80	0,50	2761	284	A1.000.275
6	6-6	P3H	30	0,55	2790	IE2	235	305	13	37,00	32,70	0,70	3307	309	A1.000.276
7	6-6	P3H	35	1,10	2871	IE3	235	331	18	37,80	33,40	0,90	3832	359	A1.000.277

N-P: number of blades - available positions

LM: indicative

eff_g: efficiency on optimal point (aerolic efficiency x motor efficiency)

All data concerning efficiency is given for working without frequency inverter and based on installation mode A - Static

V_{opt}: Volume flow on optimal point

P_{opt}: Pressure on optimal point

The specific ratio for all fans is ~1,00

P_{in}: Electrical active power at max. efficiency working point

In case of empty cells: ErP non applicable if power < 125W

Curves

Static pressure (p) [Pa]

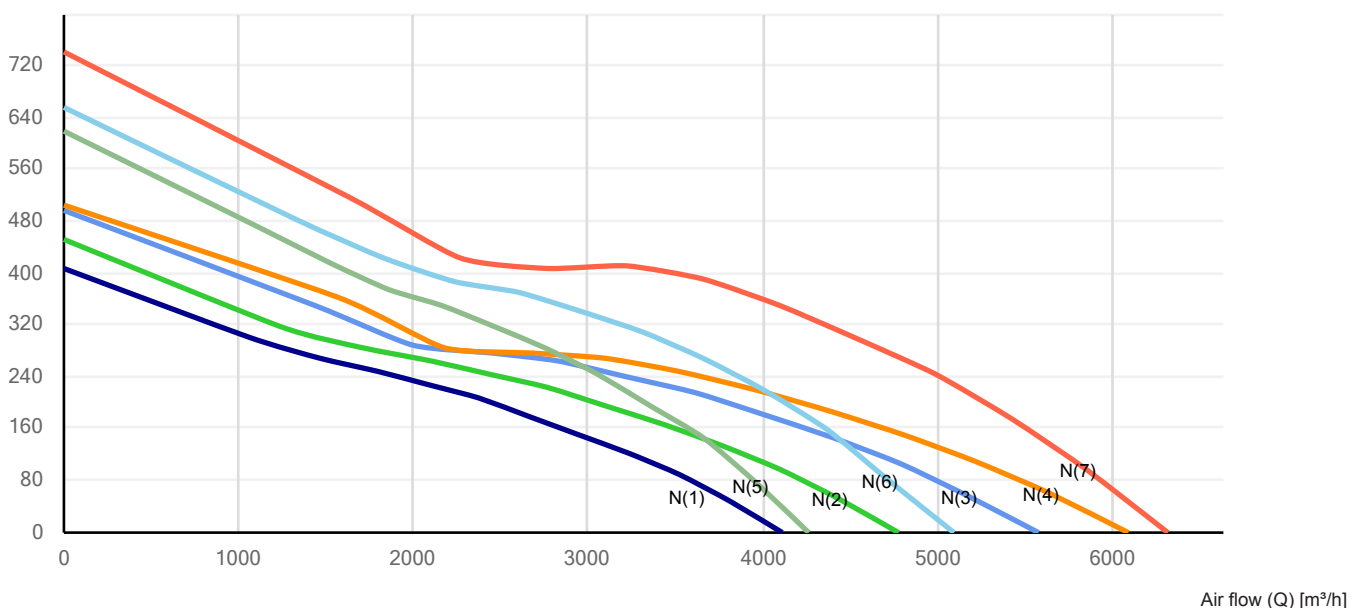

This information can be incorrect due to mistakes and may be changed at any time without prior notice.

Characteristics

- Axial fan with welded steel casing
- Fan casing, hot dip galvanized after manufacturing
- Asynchronous 3-phased multi-voltage motor 230/400V 50Hz (if <5.5kW) or 400/690V (if >= 5.5kW)
- Impeller with glass-reinforced nylon blades
- Standard cast aluminium hub and IEC central boring, with key way

Drawing and dimensions

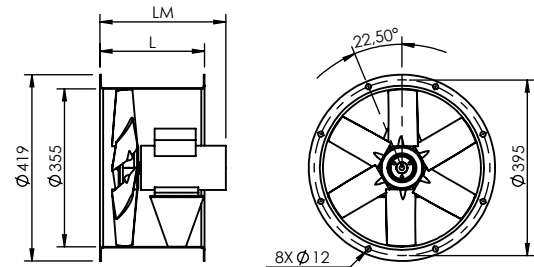

Special configurations

- Dimensions (fan diameter, flanges, casing length, ...) according to customer's requirements
- Stainless steel casing
- ATEX execution for zone 1/21 and/or zone 2/22
- Cast aluminium blades
- Single-phase motor (up to 2.2kW, 2 and 4 poles)
- Hydraulic motor
- Special executions on demand

Motor, noise and ErP data according to EU 327/2011

Curve N(#)	N-P	Type	Pitch (°)	Power (kW)	Speed (RPM)	IE	L (mm)	LM (mm)	Weight (kg)	eff _o (%)	eff target (%)	P _{in1} (kW)	V _{opt1} (m³/h)	P _{opt1} (Pa)	Article code
1	3-6	P3H	25	0,12	1400	IE2	235	283	11						A1.000.278
2	6-6	P3H	30	0,12	1400	IE2	235	283	11						A1.000.279
3	6-6	P3H	40	0,12	1400	IE2	235	283	11						A1.000.280

N-P: number of blades - available positions

LM: indicative

eff_o: efficiency on optimal point (aerolic efficiency x motor efficiency)

All data concerning efficiency is given for working without frequency inverter and based on installation mode A - Static

V_{opt}: Volume flow on optimal point

P_{opt}: Pressure on optimal point

The specific ratio for all fans is ~1,00

P_{in}: Electrical active power at max. efficiency working point

In case of empty cells: ErP non applicable if power < 125W

Curves

Static pressure (p) [Pa]

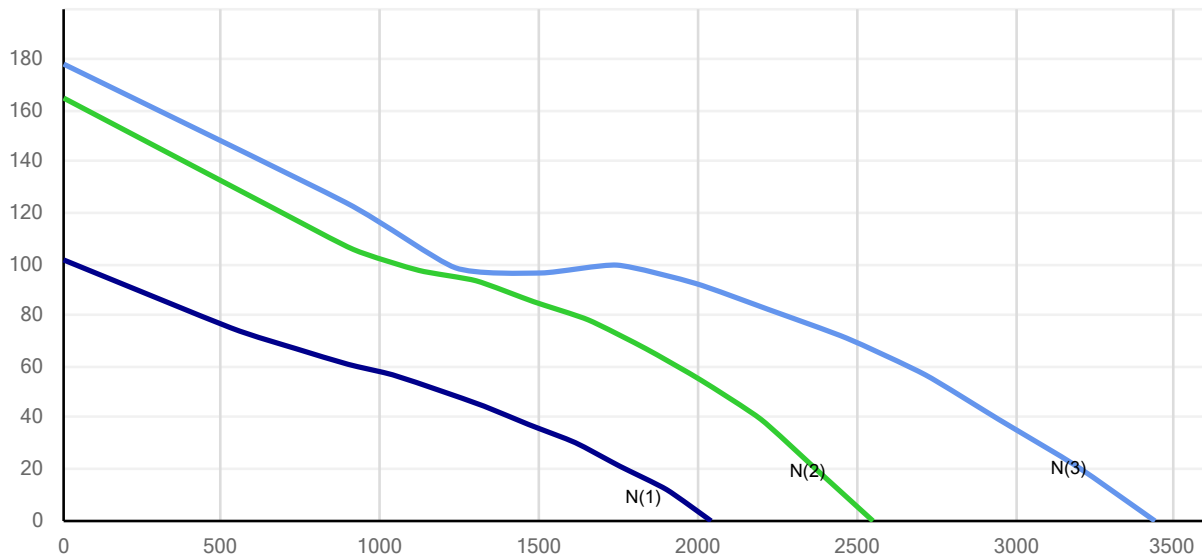

Air flow (Q) [m³/h]

Characteristics

- Axial fan with welded steel casing
- Fan casing, hot dip galvanized after manufacturing
- Asynchronous 3-phased multi-voltage motor 230/400V 50Hz (if <5.5kW) or 400/690V (if >= 5.5kW)
- Impeller with glass-reinforced nylon blades
- Standard cast aluminium hub and IEC central boring, with key way

Drawing and dimensions

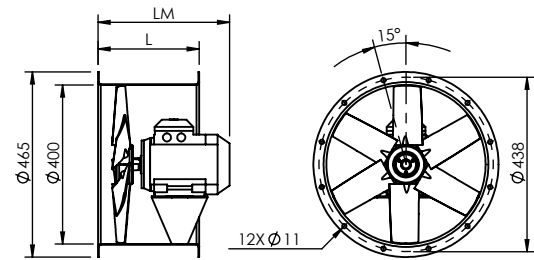

Special configurations

- Dimensions (fan diameter, flanges, casing length, ...) according to customer's requirements
- Stainless steel casing
- ATEX execution for zone 1/21 and/or zone 2/22
- Cast aluminium blades
- Single-phase motor (up to 2.2kW, 2 and 4 poles)
- Hydraulic motor
- Special executions on demand

Motor, noise and ErP data according to EU 327/2011

Curve N(#)	N-P	Type	Pitch (°)	Power (kW)	Speed (RPM)	IE	L (mm)	LM (mm)	Weight (kg)	eff _g (%)	eff target (%)	P _{in1} (kW)	V _{opt1} (m³/h)	P _{opt1} (Pa)	Article code
1	3-6	P3H	25	0,37	2800	IE2	254	305	13	38,30	31,40	0,40	3186	214	A1.000.281
2	3-6	P3H	30	0,55	2790	IE2	254	305	14	38,80	32,10	0,60	3755	235	A1.000.282
3	3-6	P3H	35	0,75	2885	IE3	254	331	19	39,40	33,10	0,80	4465	282	A1.000.283
5	3-6	P3H	40	1,10	2871	IE3	254	331	19	37,60	33,50	0,90	4915	288	A1.000.284
4	6-6	P3H	25	0,75	2885	IE3	254	331	19	41,40	32,90	0,70	4031	306	A1.000.285
6	6-6	P3H	30	1,10	2871	IE3	254	331	20	40,80	33,60	1,00	4287	366	A1.000.286
7	10-10	P3H	30	1,50	2900	IE3	254	375	26	36,60	35,00	1,60	4800	489	A1.000.287

N-P: number of blades - available positions

LM: indicative

eff_g: efficiency on optimal point (aerolic efficiency x motor efficiency)

All data concerning efficiency is given for working without frequency inverter and based on installation mode A - Static

V_{opt1}: Volume flow on optimal point

P_{opt1}: Pressure on optimal point

The specific ratio for all fans is ~1,00

P_{in1}: Electrical active power at max. efficiency working point

In case of empty cells: ErP non applicable if power < 125W

Curves

Static pressure (p) [Pa]

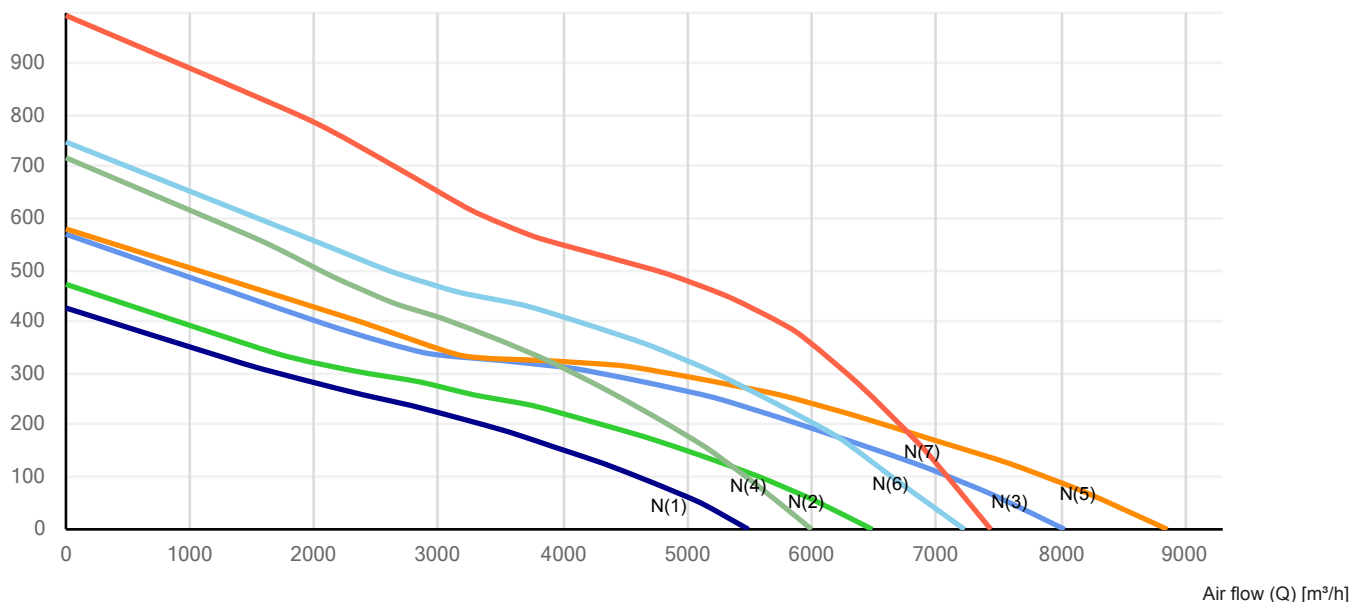

This information can be incorrect due to mistakes and may be changed at any time without prior notice.

Characteristics

- Axial fan with welded steel casing
- Fan casing, hot dip galvanized after manufacturing
- Asynchronous 3-phased multi-voltage motor 230/400V 50Hz (if <5.5kW) or 400/690V (if >= 5.5kW)
- Impeller with glass-reinforced nylon blades
- Standard cast aluminium hub and IEC central boring, with key way

Drawing and dimensions

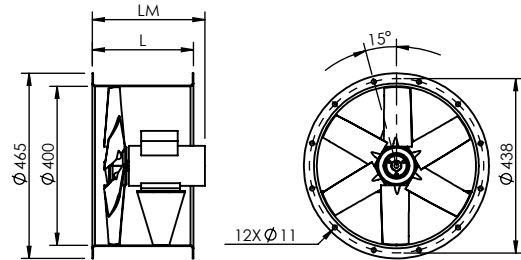

Special configurations

- Dimensions (fan diameter, flanges, casing length, ...) according to customer's requirements
- Stainless steel casing
- ATEX execution for zone 1/21 and/or zone 2/22
- Cast aluminium blades
- Single-phase motor (up to 2.2kW, 2 and 4 poles)
- Hydraulic motor
- Special executions on demand

Motor, noise and ErP data according to EU 327/2011

Curve N(#)	N-P	Type	Pitch (°)	Power (kW)	Speed (RPM)	IE	L (mm)	LM (mm)	Weight (kg)	eff _s (%)	eff target (%)	P _{in1} (kW)	V _{opt1} (m³/h)	P _{opt1} (Pa)	Article code
1	3-6	P3H	25	0,12	1400	IE2	254	283	12						A1.000.288
2	3-6	P3H	30	0,12	1400	IE2	254	283	12						A1.000.289
3	3-6	P3H	35	0,12	1400	IE2	254	283	12						A1.000.290
4	3-6	P3H	40	0,12	1400	IE2	254	283	12						A1.000.291
5	6-6	P3H	25	0,12	1400	IE2	254	283	13						A1.000.292
6	6-6	P3H	30	0,12	1400	IE2	254	283	13						A1.000.293
7	6-6	P3H	35	0,18	1380	IE2	254	283	13	30,50	29,20	0,20	2451	98	A1.000.294

N-P: number of blades - available positions

LM: indicative

eff_s: efficiency on optimal point (aerolic efficiency x motor efficiency)

All data concerning efficiency is given for working without frequency inverter and based on installation mode A - Static

V_{opt1}: Volume flow on optimal point

P_{opt1}: Pressure on optimal point

The specific ratio for all fans is ~1,00

P_{in1}: Electrical active power at max. efficiency working point

In case of empty cells: ErP non applicable if power < 125W

Curves

Static pressure (p) [Pa]

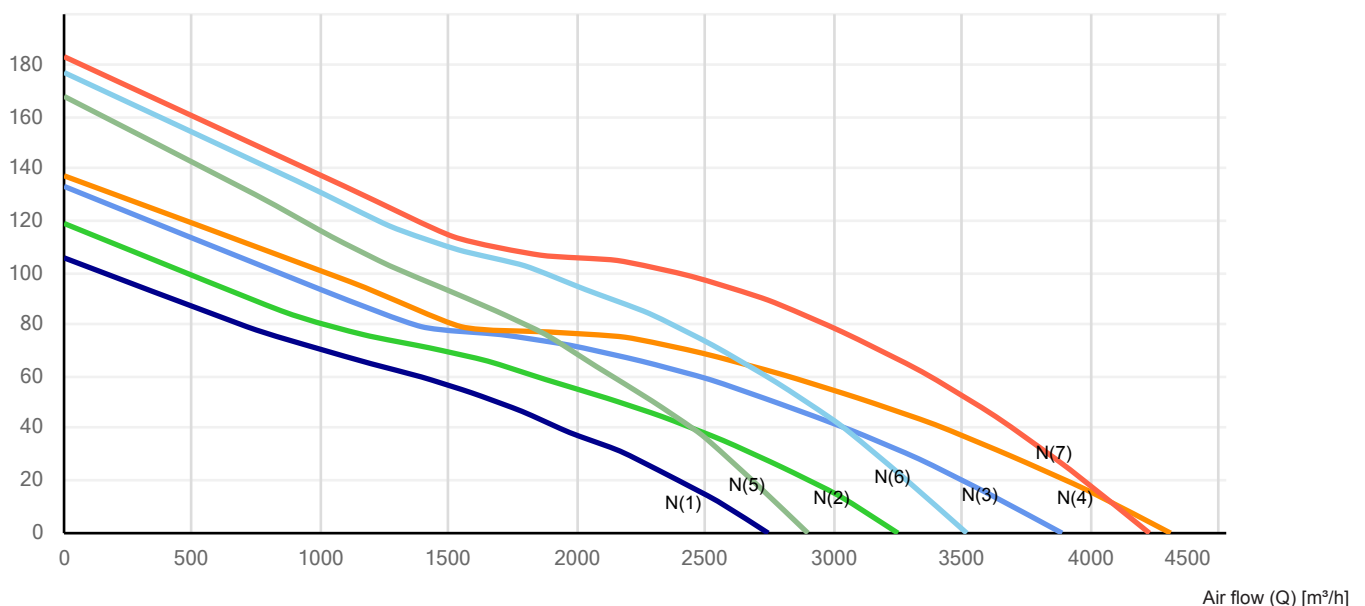

This information can be incorrect due to mistakes and may be changed at any time without prior notice.

Characteristics

- Axial fan with welded steel casing
- Fan casing, hot dip galvanized after manufacturing
- Asynchronous 3-phased multi-voltage motor 230/400V 50Hz (if <5.5kW) or 400/690V (if >= 5.5kW)
- Impeller with glass-reinforced nylon blades
- Standard cast aluminium hub and IEC central boring, with key way

Drawing and dimensions

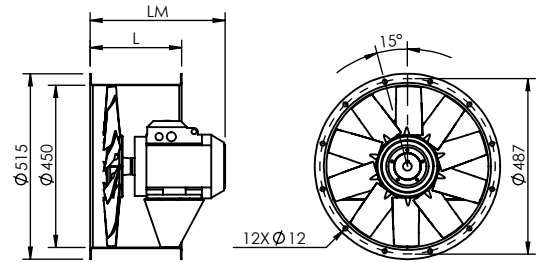

Special configurations

- Dimensions (fan diameter, flanges, casing length, ...) according to customer's requirements
- Stainless steel casing
- ATEX execution for zone 1/21 and/or zone 2/22
- Cast aluminium blades
- Single-phase motor (up to 2.2kW, 2 and 4 poles)
- Hydraulic motor
- Special executions on demand

Motor, noise and ErP data according to EU 327/2011

Curve N(#)	N-P	Type	Pitch (°)	Power (kW)	Speed (RPM)	IE	L (mm)	LM (mm)	Weight (kg)	eff _o (%)	eff target (%)	P _{in1} (kW)	V _{opt1} (m³/h)	P _{opt1} (Pa)	Article code
1	3-6	P3H	25	0,55	2790	IE2	254	305	15	41,50	32,00	0,50	3569	252	A1.000.295
2	3-6	P3H	30	0,75	2885	IE3	254	331	20	41,30	33,10	0,80	4838	280	A1.000.296
3	3-6	P3H	35	1,10	2871	IE3	254	331	21	41,00	34,00	1,10	6001	306	A1.000.297
4	6-6	P3H	25	1,10	2871	IE3	254	331	21	42,70	33,70	1,00	4815	355	A1.000.298
5	10-10	P3H	25	2,20	2903	IE3	254	375	29	39,50	35,20	1,80	5335	525	A1.000.299
6	10-10	P3H	30	2,20	2903	IE3	254	375	29	38,70	36,00	2,30	6742	535	A1.000.300

N-P: number of blades - available positions

LM: indicative

eff_o: efficiency on optimal point (aerolic efficiency x motor efficiency)

All data concerning efficiency is given for working without frequency inverter and based on installation mode A - Static

V_{opt}: Volume flow on optimal point

P_{opt}: Pressure on optimal point

The specific ratio for all fans is ~1,00

P_{in}: Electrical active power at max. efficiency working point

In case of empty cells: ErP non applicable if power < 125W

Curves

Static pressure (p) [Pa]

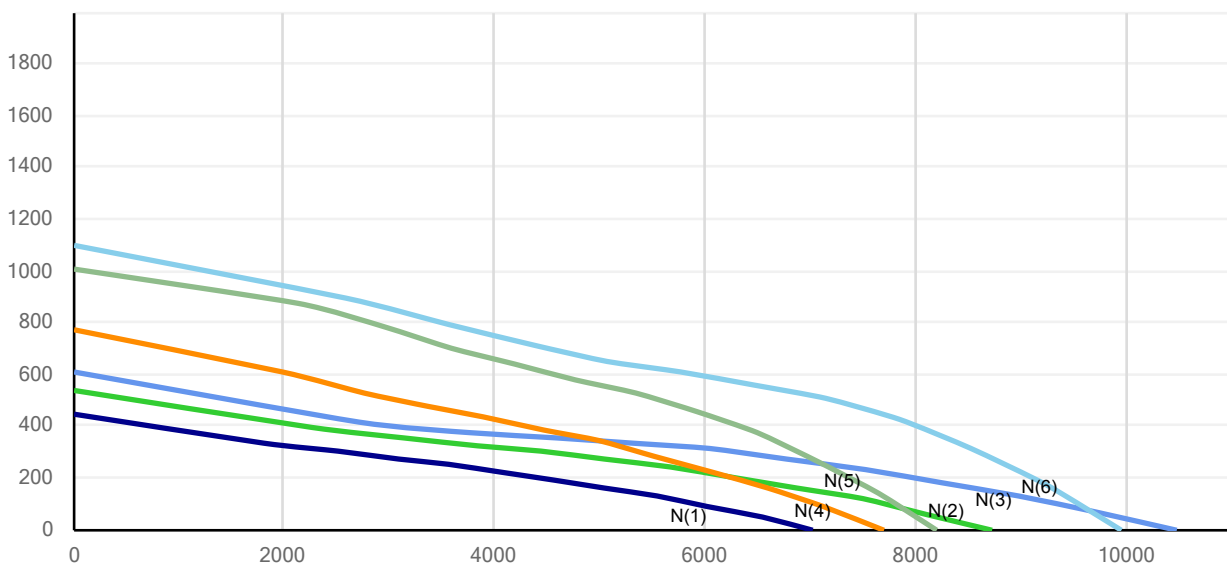

Air flow (Q) [m³/h]

Characteristics

- Axial fan with welded steel casing
- Fan casing, hot dip galvanized after manufacturing
- Asynchronous 3-phased multi-voltage motor 230/400V 50Hz (if <5.5kW) or 400/690V (if >= 5.5kW)
- Impeller with glass-reinforced nylon blades
- Standard cast aluminium hub and IEC central boring, with key way

Drawing and dimensions

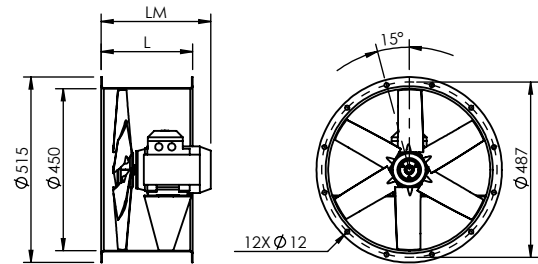

Special configurations

- Dimensions (fan diameter, flanges, casing length, ...) according to customer's requirements
- Stainless steel casing
- ATEX execution for zone 1/21 and/or zone 2/22
- Cast aluminium blades
- Single-phase motor (up to 2.2kW, 2 and 4 poles)
- Hydraulic motor
- Special executions on demand

Motor, noise and ErP data according to EU 327/2011

Curve N(#)	N-P	Type	Pitch (°)	Power (kW)	Speed (RPM)	IE	L (mm)	LM (mm)	Weight (kg)	eff _o (%)	eff target (%)	P _{in1} (kW)	V _{opt1} (m³/h)	P _{opt1} (Pa)	Article code
1	3-6	P3H	25	0,12	1400	IE2	254	283	14						A1.000.301
2	3-6	P3H	30	0,12	1400	IE2	254	283	14						A1.000.302
3	3-6	P3H	35	0,12	1400	IE2	254	283	14						A1.000.303
4	6-6	P3H	25	0,12	1400	IE2	254	283	14						A1.000.304
5	6-6	P3H	30	0,18	1380	IE2	254	283	14	33,60	29,20	0,20	2616	99	A1.000.305
6	6-6	P3H	35	0,25	1365	IE2	254	305	15	31,00	30,10	0,30	3191	106	A1.000.306

N-P: number of blades - available positions

LM: indicative

eff_o: efficiency on optimal point (aerolic efficiency x motor efficiency)

All data concerning efficiency is given for working without frequency inverter and based on installation mode A - Static

V_{opt1}: Volume flow on optimal point

P_{opt1}: Pressure on optimal point

The specific ratio for all fans is ~1,00

P_{in1}: Electrical active power at max. efficiency working point

In case of empty cells: ErP non applicable if power < 125W

Curves

Static pressure (p) [Pa]

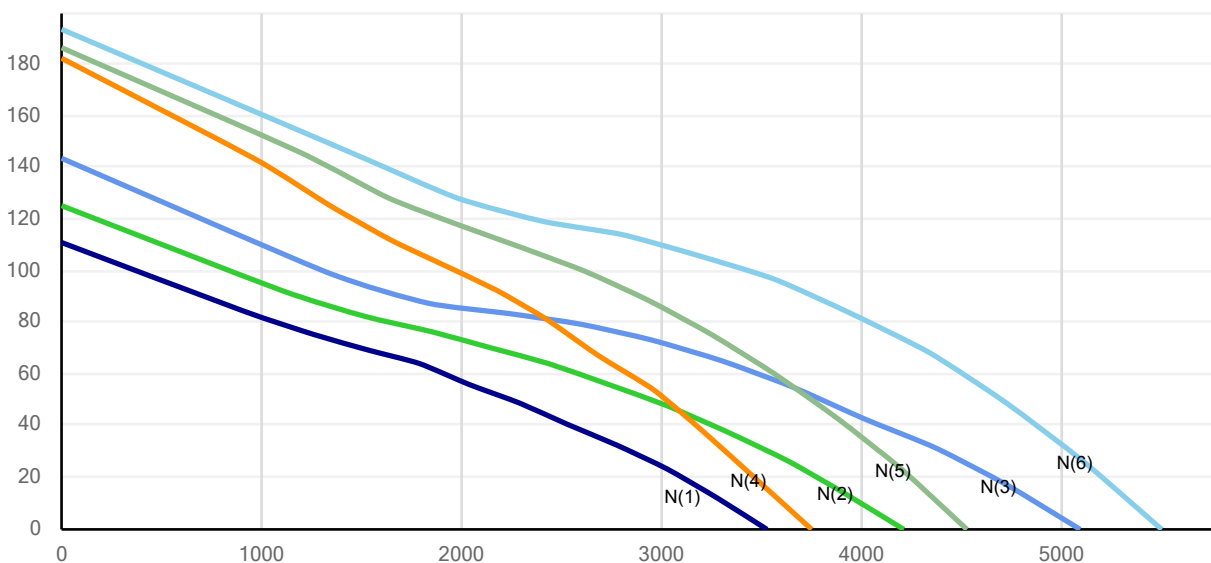

Air flow (Q) [m³/h]

Characteristics

- Axial fan with welded steel casing
- Fan casing, hot dip galvanized after manufacturing
- Asynchronous 3-phased multi-voltage motor 230/400V 50Hz (if <5.5kW) or 400/690V (if >= 5.5kW)
- Impeller with glass-reinforced nylon blades
- Standard cast aluminium hub and IEC central boring, with key way

Drawing and dimensions

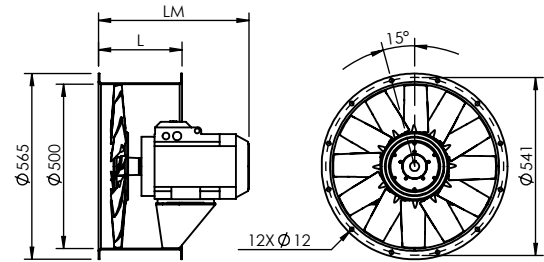

Special configurations

- Dimensions (fan diameter, flanges, casing length, ...) according to customer's requirements
- Stainless steel casing
- ATEX execution for zone 1/21 and/or zone 2/22
- Cast aluminium blades
- Single-phase motor (up to 2.2kW, 2 and 4 poles)
- Hydraulic motor
- Special executions on demand

Motor, noise and ErP data according to EU 327/2011

Curve N(#)	N-P	Type	Pitch (°)	Power (kW)	Speed (RPM)	IE	L (mm)	LM (mm)	Weight (kg)	eff _s (%)	eff target (%)	P _{in1} (kW)	V _{opt1} (m³/h)	P _{opt1} (Pa)	Article code
1	3-6	P3H	25	0,75	2885	IE3	254	331	25	42,60	33,00	0,80	4615	290	A1.000.307
2	3-6	P3H	30	1,10	2871	IE3	254	331	25	42,60	33,80	1,10	5896	307	A1.000.308
3	12-12	P3H	25	3,00	2897	IE3	254	416	42	39,90	36,80	3,10	7249	694	A1.000.310
4	12-12	P3H	30	4,00	2873	IE3	254	458	47	39,40	37,40	3,90	8812	702	A1.000.311
5	10-10	P3H	35	5,50	2914	IE3	254	458	58	40,60	37,90	4,60	10916	690	A1.000.309

N-P: number of blades - available positions

LM: indicative

eff_s: efficiency on optimal point (aerolic efficiency x motor efficiency)

All data concerning efficiency is given for working without frequency inverter and based on installation mode A - Static

V_{opt}: Volume flow on optimal point

P_{opt}: Pressure on optimal point

The specific ratio for all fans is ~1,00

P_{in}: Electrical active power at max. efficiency working point

In case of empty cells: ErP non applicable if power < 125W

Curves

Static pressure (p) [Pa]

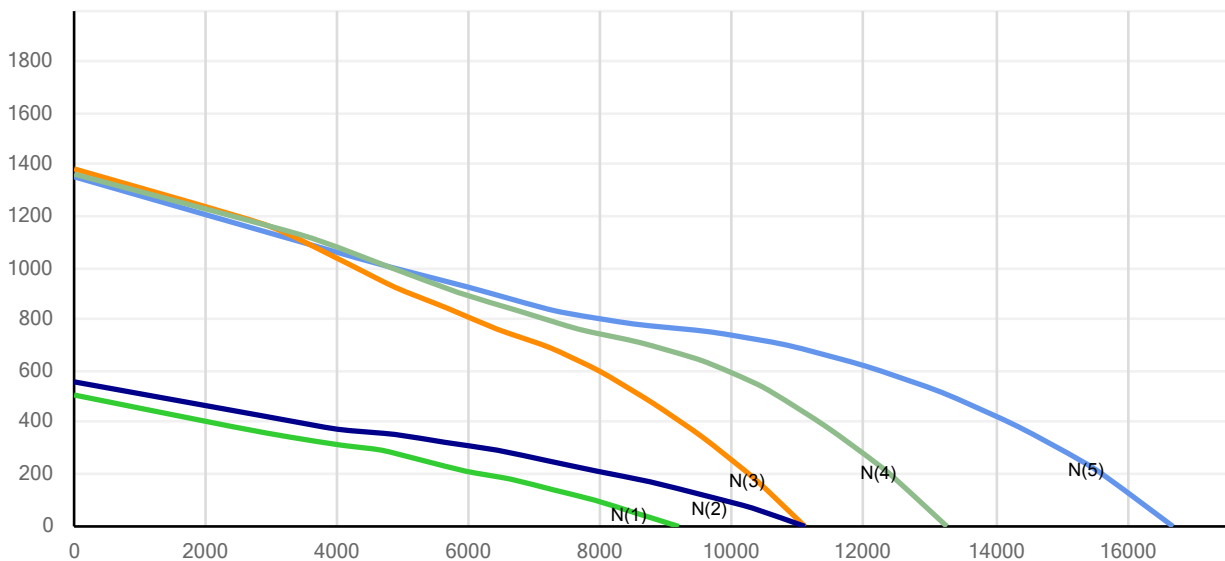

Air flow (Q) [m³/h]

Characteristics

- Axial fan with welded steel casing
- Fan casing, hot dip galvanized after manufacturing
- Asynchronous 3-phased multi-voltage motor 230/400V 50Hz (if <5.5kW) or 400/690V (if >= 5.5kW)
- Impeller with glass-reinforced nylon blades
- Standard cast aluminium hub and IEC central boring, with key way

Drawing and dimensions

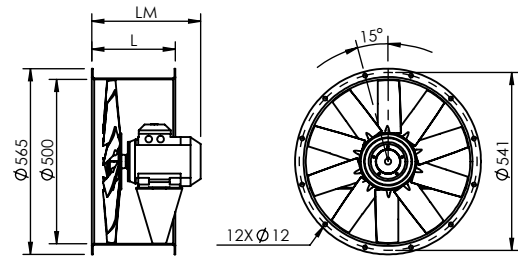

Special configurations

- Dimensions (fan diameter, flanges, casing length, ...) according to customer's requirements
- Stainless steel casing
- ATEX execution for zone 1/21 and/or zone 2/22
- Cast aluminium blades
- Single-phase motor (up to 2.2kW, 2 and 4 poles)
- Hydraulic motor
- Special executions on demand

Motor, noise and ErP data according to EU 327/2011

Curve N(#)	N-P	Type	Pitch (°)	Power (kW)	Speed (RPM)	IE	L (mm)	LM (mm)	Weight (kg)	eff _o (%)	eff target (%)	P _{in1} (kW)	V _{opt1} (m³/h)	P _{opt1} (Pa)	Article code
1	3-6	P3H	25	0,12	1400	IE2	254	283	14						A1.000.312
2	6-6	P3H	25	0,18	1380	IE2	254	283	15	34,50	29,10	0,20	2717	97	A1.000.313
4	10-10	P3H	25	0,25	1365	IE2	254	305	20	31,40	30,80	0,30	3344	131	A1.000.314
3	10-10	P3H	30	0,37	1375	IE2	254	305	21	32,10	31,50	0,50	4115	144	A1.000.315
5	10-10	P3H	35	0,55	1375	IE2	254	331	24	32,50	32,30	0,60	5113	155	A1.000.316
6	10-10	P3H	40	0,75	1437	IE3	254	326	27	36,60	32,60	0,70	5219	189	A1.001.451

N-P: number of blades - available positions

LM: indicative

eff_o: efficiency on optimal point (aerolic efficiency x motor efficiency)

All data concerning efficiency is given for working without frequency inverter and based on installation mode A - Static

V_{opt1}: Volume flow on optimal point

P_{opt1}: Pressure on optimal point

The specific ratio for all fans is ~1,00

P_{in1}: Electrical active power at max. efficiency working point

In case of empty cells: ErP non applicable if power < 125W

Curves

Static pressure (p) [Pa]

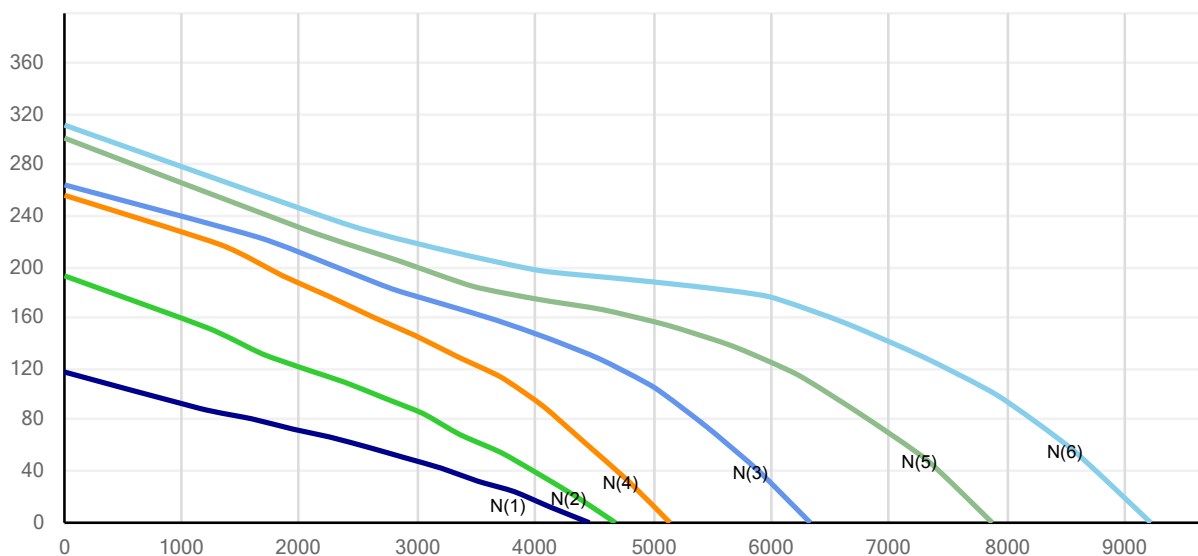

Air flow (Q) [m³/h]

This information can be incorrect due to mistakes and may be changed at any time without prior notice.

Characteristics

- Axial fan with welded steel casing
- Fan casing, hot dip galvanized after manufacturing
- Asynchronous 3-phased multi-voltage motor 230/400V 50Hz (if <5.5kW) or 400/690V (if >= 5.5kW)
- Impeller with glass-reinforced nylon blades
- Standard cast aluminium hub and IEC central boring, with key way

Drawing and dimensions

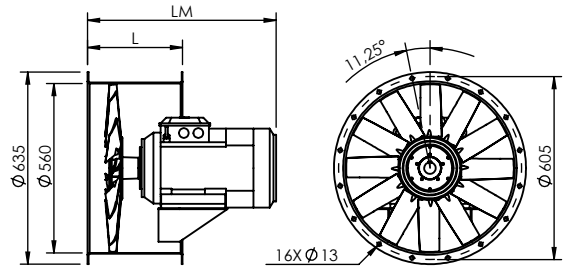

Special configurations

- Dimensions (fan diameter, flanges, casing length, ...) according to customer's requirements
- Stainless steel casing
- ATEX execution for zone 1/21 and/or zone 2/22
- Cast aluminium blades
- Single-phase motor (up to 2.2kW, 2 and 4 poles)
- Hydraulic motor
- Special executions on demand

Motor, noise and ErP data according to EU 327/2011

Curve N(#)	N-P	Type	Pitch (°)	Power (kW)	Speed (RPM)	IE	L (mm)	LM (mm)	Weight (kg)	eff _o (%)	eff target (%)	P _{in1} (kW)	V _{opt1} (m³/h)	P _{opt1} (Pa)	Article code
1	3-6	P3H	25	1,10	2871	IE3	314	331	25	43,00	33,80	1,00	5806	306	A1.000.318
2	12-12	P3H	25	4,00	2873	IE3	314	458	47	42,10	37,60	4,20	9419	745	A1.000.319
3	12-12	P3H	30	5,50	2914	IE3	314	537	60	41,80	38,40	5,70	11781	812	A1.000.320
4	12-12	P3H	35	7,50	2901	IE3	314	623	101	39,90	39,30	7,80	14373	865	A1.000.321

N-P: number of blades - available positions

LM: indicative

eff_o: efficiency on optimal point (aerolic efficiency x motor efficiency)

All data concerning efficiency is given for working without frequency inverter and based on installation mode A - Static

V_{opt}: Volume flow on optimal point

P_{opt}: Pressure on optimal point

The specific ratio for all fans is ~1,00

P_{in1}: Electrical active power at max. efficiency working point
In case of empty cells: ErP non applicable if power < 125W

Curves

Static pressure (p) [Pa]

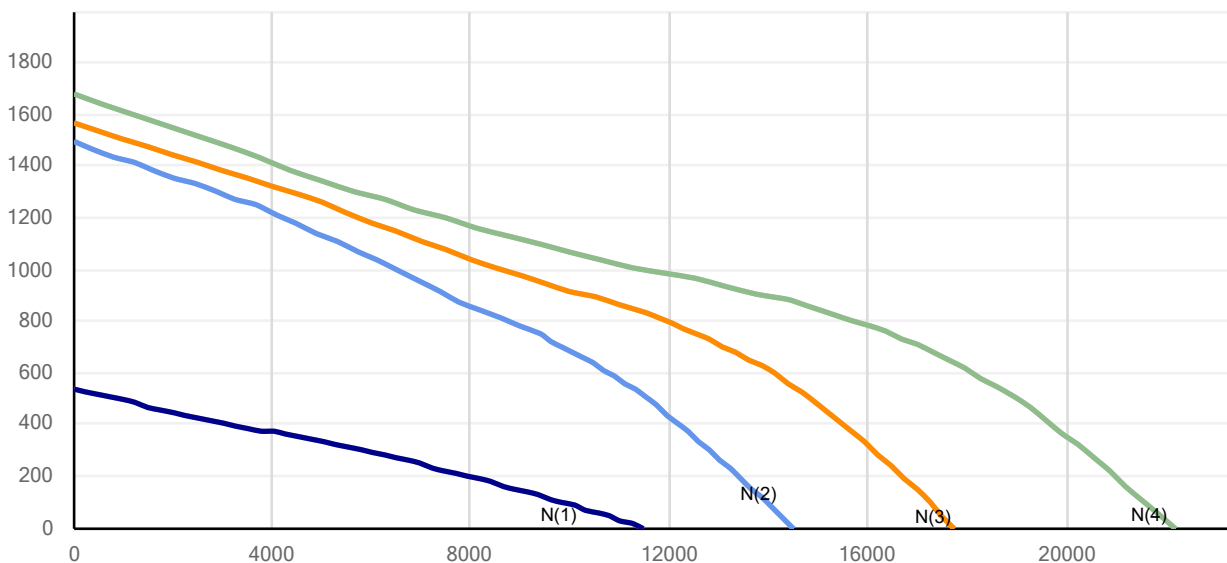

Air flow (Q) [m³/h]

Characteristics

- Axial fan with welded steel casing
- Fan casing, hot dip galvanized after manufacturing
- Asynchronous 3-phased multi-voltage motor 230/400V 50Hz (if <5.5kW) or 400/690V (if >= 5.5kW)
- Impeller with glass-reinforced nylon blades
- Standard cast aluminium hub and IEC central boring, with key way

Drawing and dimensions

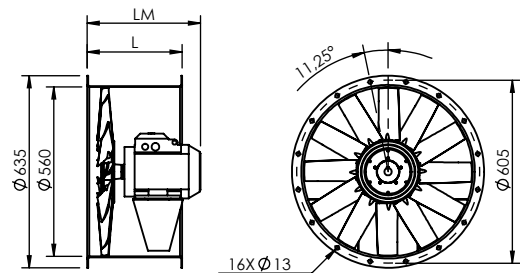

Special configurations

- Dimensions (fan diameter, flanges, casing length, ...) according to customer's requirements
- Stainless steel casing
- ATEX execution for zone 1/21 and/or zone 2/22
- Cast aluminium blades
- Single-phase motor (up to 2.2kW, 2 and 4 poles)
- Hydraulic motor
- Special executions on demand

Motor, noise and ErP data according to EU 327/2011

Curve N(#)	N-P	Type	Pitch (°)	Power (kW)	Speed (RPM)	IE	L (mm)	LM (mm)	Weight (kg)	eff _o (%)	eff target (%)	P _{in1} (kW)	V _{opt1} (m³/h)	P _{opt1} (Pa)	Article code
1	3-6	P3H	25	0,12	1400	IE2	314	314	18						A1.000.322
2	6-6	P3H	25	0,18	1380	IE2	314	314	19	35,00	30,00	0,30	3451	107	A1.000.323
3	6-6	P3H	30	0,37	1375	IE2	314	314	20	36,20	31,00	0,40	4310	125	A1.000.324
4	6-6	P3H	35	0,55	1375	IE2	314	331	23	35,90	31,90	0,50	6046	124	A1.000.325
5	6-6	P3H	40	0,55	1375	IE2	314	331	23	34,40	32,50	0,70	6149	147	A1.000.326
6	10-10	P3H	40	1,10	1437	IE3	314	375	32	38,60	33,80	1,00	7047	226	A1.000.327
7	12-12	P3H	35	1,10	1437	IE3	314	375	32	37,70	33,70	1,00	7122	215	A1.000.329
8	10-10	P3H	45	1,50	1445	IE3	314	375	33	37,00	34,40	1,30	8132	235	A1.000.328

N-P: number of blades - available positions

LM: indicative

eff_o: efficiency on optimal point (aerolic efficiency x motor efficiency)

All data concerning efficiency is given for working without frequency inverter and based on installation mode A - Static

V_{opt}: Volume flow on optimal point

P_{opt}: Pressure on optimal point

The specific ratio for all fans is ~1,00

P_{in}: Electrical active power at max. efficiency working point

In case of empty cells: ErP non applicable if power < 125W

Curves

Static pressure (p) [Pa]

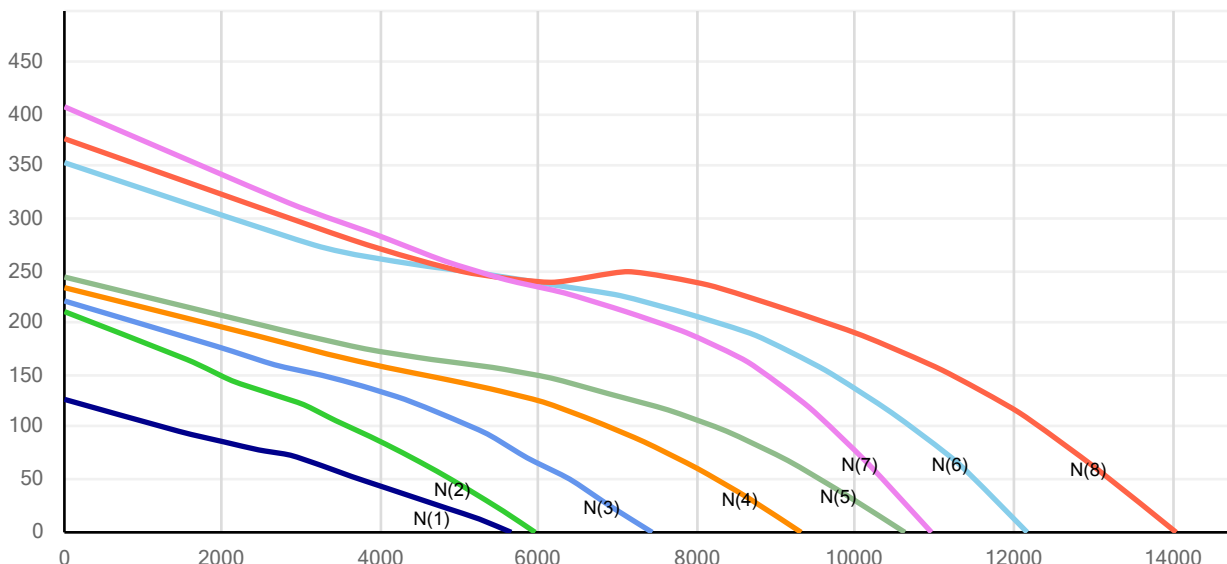

Air flow (Q) [m³/h]

This information can be incorrect due to mistakes and may be changed at any time without prior notice.

Characteristics

- Axial fan with welded steel casing
- Fan casing, hot dip galvanized after manufacturing
- Asynchronous 3-phased multi-voltage motor 230/400V 50Hz (if <5.5kW) or 400/690V (if >= 5.5kW)
- Impeller with glass-reinforced nylon blades
- Standard cast aluminium hub and IEC central boring, with key way

Drawing and dimensions

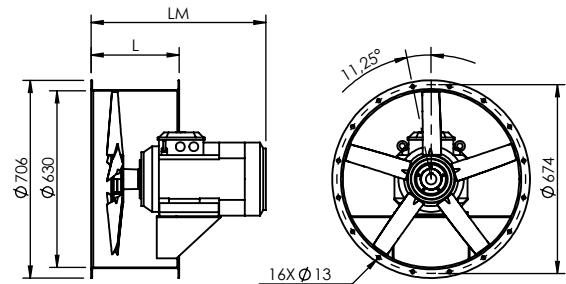

Special configurations

- Dimensions (fan diameter, flanges, casing length, ...) according to customer's requirements
- Stainless steel casing
- ATEX execution for zone 1/21 and/or zone 2/22
- Cast aluminium blades
- Hydraulic motor
- Special executions on demand

Motor, noise and ErP data according to EU 327/2011

Curve N(#)	N-P	Type	Pitch (°)	Power (kW)	Speed (RPM)	IE	L (mm)	LM (mm)	Weight (kg)	eff _o (%)	eff target (%)	P _{in1} (kW)	V _{opt1} (m³/h)	P _{opt1} (Pa)	Article code
1	5-10	P3H	25	3,00	2897	IE3	314	441	49	46,00	36,60	2,90	10191	528	A1.000.330
2	5-10	P3H	30	4,00	2873	IE3	314	483	54	46,80	37,50	4,00	11862	636	A1.000.331
3	5-5	P4Z	20	4,00	2873	IE3	314	483	54	44,70	37,30	3,80	11655	583	A1.000.334
4	5-5	P5Z	25	5,50	2914	IE3	314	493	93	46,00	38,40	5,70	14525	725	A1.000.335
5	5-10	P3H	35	7,50	2901	IE3	314	623	107	44,40	38,60	6,00	15839	676	A1.000.332
6	5-10	P3H	40	7,50	2901	IE3	314	623	107	42,50	39,20	7,40	17926	705	A1.000.333

N-P: number of blades - available positions

LM: indicative

eff_o: efficiency on optimal point (aerolic efficiency x motor efficiency)

All data concerning efficiency is given for working without frequency inverter and based on installation mode A - Static

V_{opt1}: Volume flow on optimal point

P_{opt1}: Pressure on optimal point

The specific ratio for all fans is ~1,00

P_{in1}: Electrical active power at max. efficiency working point

In case of empty cells: ErP non applicable if power < 125W

Curves

Static pressure (p) [Pa]

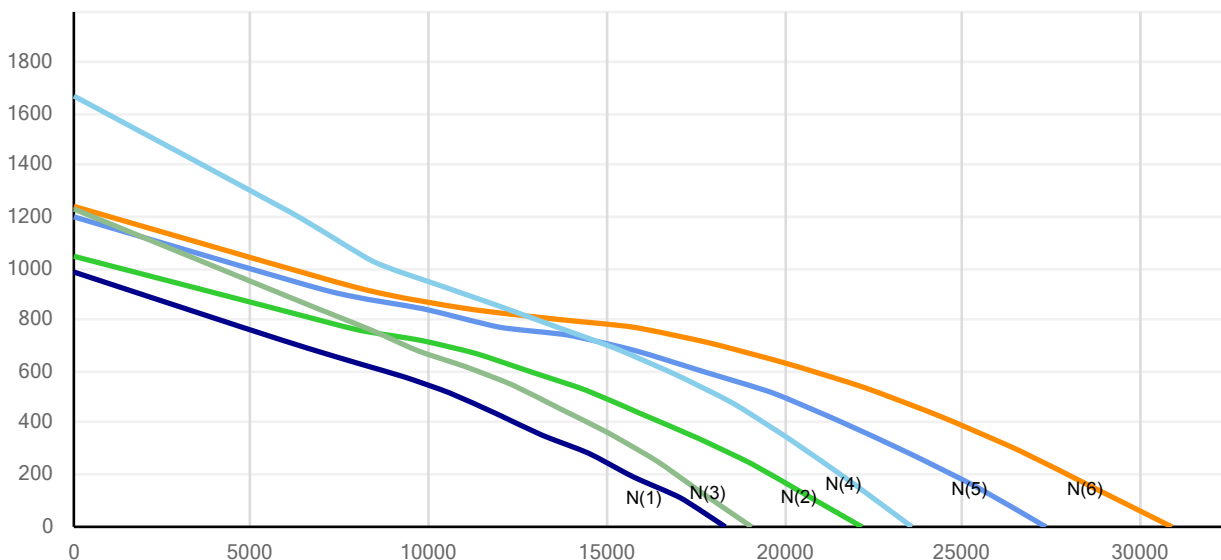

Air flow (Q) [m³/h]

Characteristics

- Axial fan with welded steel casing
- Fan casing, hot dip galvanized after manufacturing
- Asynchronous 3-phased multi-voltage motor 230/400V 50Hz (if <5.5kW) or 400/690V (if >= 5.5kW)
- Impeller with glass-reinforced nylon blades
- Standard cast aluminium hub and IEC central boring, with key way

Drawing and dimensions

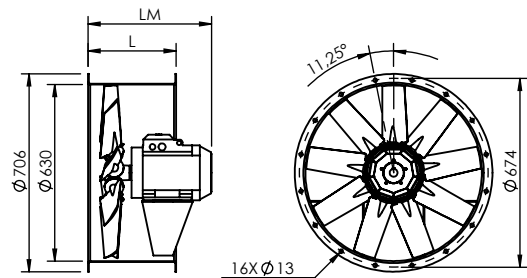

Special configurations

- Dimensions (fan diameter, flanges, casing length, ...) according to customer's requirements
- Stainless steel casing
- ATEX execution for zone 1/21 and/or zone 2/22
- Cast aluminium blades
- Single-phase motor (up to 2.2kW, 2 and 4 poles)
- Hydraulic motor
- Special executions on demand

Motor, noise and ErP data according to EU 327/2011

Curve N(#)	N-P	Type	Pitch (°)	Power (kW)	Speed (RPM)	IE	L (mm)	LM (mm)	Weight (kg)	eff _o (%)	eff target (%)	P _{in1} (kW)	V _{opt1} (m³/h)	P _{opt1} (Pa)	Article code
1	5-5	P4Z	20	0,37	1375	IE2	314	330	29	35,00	31,90	0,50	5906	124	A1.000.336
2	9-9	P4Z	20	0,75	1437	IE3	314	346	37	40,70	32,90	0,70	5880	206	A1.000.340
3	7-7	P4Z	25	1,10	1437	IE3	314	400	40	39,20	33,70	1,00	7670	205	A1.000.337
4	7-7	P4Z	30	1,50	1445	IE3	314	400	41	39,00	34,50	1,40	9371	227	A1.000.338
5	7-7	P4Z	32,5	1,50	1445	IE3	314	400	41	38,00	34,90	1,60	10230	237	A1.000.338
6	9-9	P5Z	25	1,50	1445	IE3	314	400	43	39,80	34,40	1,30	7886	264	A1.000.343
7	9-9	P4Z	35	2,20	1455	IE3	314	441	52	39,60	35,50	2,00	11128	279	A1.000.341
8	9-9	P4Z	40	3,00	1445	IE3	314	441	55	37,70	36,00	2,40	12719	281	A1.000.342

N-P: number of blades - available positions

LM: indicative

eff_o: efficiency on optimal point (aerolic efficiency x motor efficiency)

All data concerning efficiency is given for working without frequency inverter and based on installation mode A - Static

V_{opt1}: Volume flow on optimal point

P_{opt1}: Pressure on optimal point

The specific ratio for all fans is ~1,00

P_{in1}: Electrical active power at max. efficiency working point

In case of empty cells: ErP non applicable if power < 125W

Curves

Static pressure (p) [Pa]

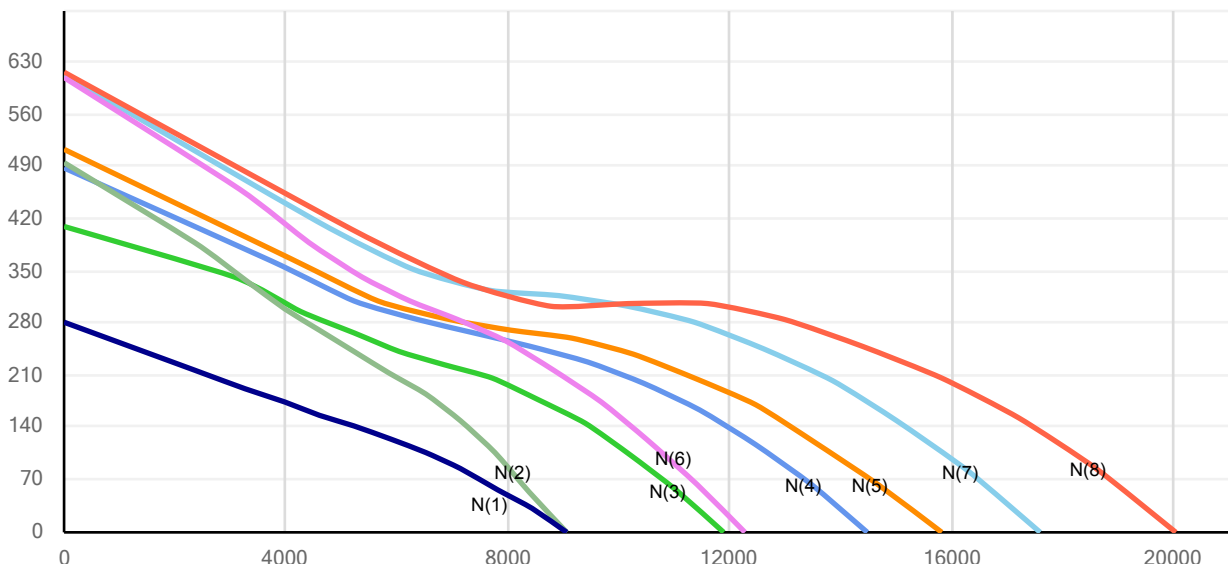

Air flow (Q) [m³/h]

This information can be incorrect due to mistakes and may be changed at any time without prior notice.

Characteristics

- Axial fan with welded steel casing
- Fan casing, hot dip galvanized after manufacturing
- Asynchronous 3-phased multi-voltage motor 230/400V 50Hz (if <5.5kW) or 400/690V (if >= 5.5kW)
- Impeller with glass-reinforced nylon blades
- Standard cast aluminium hub and IEC central boring, with key way

Drawing and dimensions

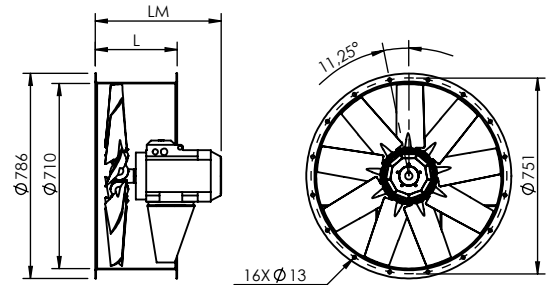

Special configurations

- Dimensions (fan diameter, flanges, casing length, ...) according to customer's requirements
- Stainless steel casing
- ATEX execution for zone 1/21 and/or zone 2/22
- Cast aluminium blades
- Single-phase motor (up to 2.2kW, 2 and 4 poles)
- Hydraulic motor
- Special executions on demand

Motor, noise and ErP data according to EU 327/2011

Curve N(#)	N-P	Type	Pitch (°)	Power (kW)	Speed (RPM)	IE	L (mm)	LM (mm)	Weight (kg)	eff _s (%)	eff target (%)	P _{in1} (kW)	V _{opt1} (m³/h)	P _{opt1} (Pa)	Article code
1	5-5	P4Z	20	0,55	1375	IE2	314	356	33	37,50	32,70	0,70	6844	152	A1.000.344
2	5-5	P5Z	25	1,10	1437	IE3	314	406	43	44,40	34,00	1,10	10162	201	A1.000.347
3	7-7	P4Z	30	2,20	1455	IE3	314	441	53	40,90	35,60	2,00	12745	261	A1.000.345
4	7-7	P5Z	32,5	2,20	1455	IE3	314	441	54	40,10	36,10	2,40	13295	290	A1.000.348
5	9-9	P5Z	25	2,20	1455	IE3	314	441	56	43,40	35,30	1,80	10442	302	A1.000.351
6	7-7	P5Z	35	3,00	1445	IE3	314	441	57	40,40	36,40	2,70	14872	294	A1.000.349
7	7-7	P5Z	37,5	3,00	1445	IE3	314	441	57	39,00	36,80	3,10	15866	303	A1.000.349
8	9-9	P4Z	40	4,00	1451	IE3	314	483	64	39,80	37,20	3,70	17880	327	A1.000.346
9	9-9	P5Z	37,5	4,00	1451	IE3	314	483	64	39,10	37,30	3,70	16614	349	A1.000.352

N-P: number of blades - available positions

LM: indicative

eff_s: efficiency on optimal point (aerolic efficiency x motor efficiency)

All data concerning efficiency is given for working without frequency inverter and based on installation mode A - Static

V_{opt}: Volume flow on optimal point

P_{opt}: Pressure on optimal point

The specific ratio for all fans is ~1,00

P_{in1}: Electrical active power at max. efficiency working point

In case of empty cells: ErP non applicable if power < 125W

Curves

Static pressure (p) [Pa]

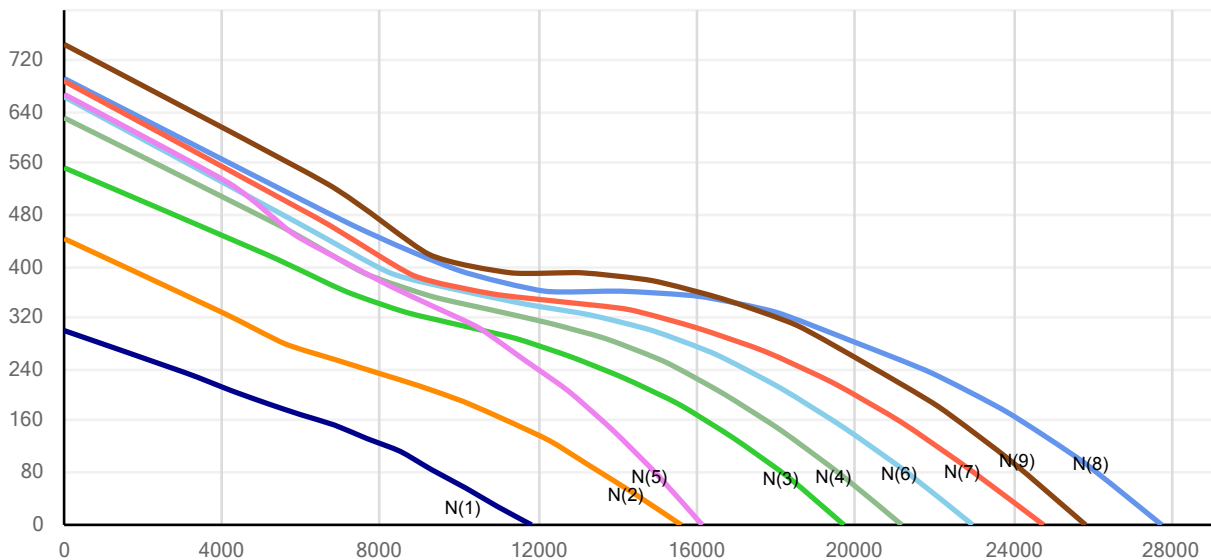

This information can be incorrect due to mistakes and may be changed at any time without prior notice.

Air flow (Q) [m³/h]

Characteristics

- Axial fan with welded steel casing
- Fan casing, hot dip galvanized after manufacturing
- Asynchronous 3-phased multi-voltage motor 230/400V 50Hz (if <5.5kW) or 400/690V (if >= 5.5kW)
- Impeller with glass-reinforced nylon blades
- Standard cast aluminium hub and IEC central boring, with key way

Drawing and dimensions

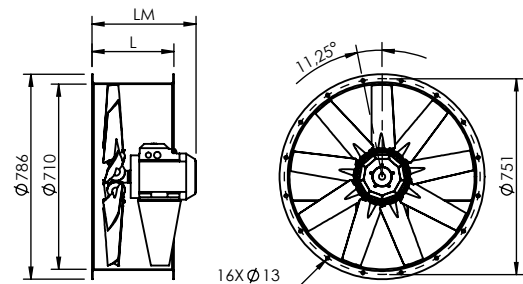

Special configurations

- Dimensions (fan diameter, flanges, casing length, ...) according to customer's requirements
- Stainless steel casing
- ATEX execution for zone 1/21 and/or zone 2/22
- Cast aluminium blades
- Hydraulic motor
- Special executions on demand

Motor, noise and ErP data according to EU 327/2011

Curve N(#)	N-P	Type	Pitch (°)	Power (kW)	Speed (RPM)	IE	L (mm)	LM (mm)	Weight (kg)	eff _o (%)	eff target (%)	P _{in1} (kW)	V _{opt1} (m³/h)	P _{opt1} (Pa)	Article code
1	5-5	P4Z	20	0,18	885	IE2	314	330	31	30,60	29,60	0,20	4392	63	A1.000.353
3	9-9	P4Z	30	0,55	905	IE2	314	356	37	34,60	32,70	0,70	8134	118	A1.000.355
4	9-9	P4Z	35	0,75	930	IE3	314	406	38	37,30	33,30	0,90	9965	131	A1.000.357
2	9-9	P5Z	25	0,37	905	IE2	314	356	46	34,40	32,10	0,50	6541	109	A1.000.354
6	9-9	P4Z	40	1,10	928	IE3	314	406	47	36,40	33,90	1,10	11523	137	A1.000.358
5	9-9	P5Z	32,5	0,75	930	IE3	314	406	48	36,50	33,30	0,90	9139	138	A1.000.356

N-P: number of blades - available positions

LM: indicative

eff_o: efficiency on optimal point (aerolic efficiency x motor efficiency)

All data concerning efficiency is given for working without frequency inverter and based on installation mode A - Static

V_{opt1}: Volume flow on optimal point

P_{opt1}: Pressure on optimal point

The specific ratio for all fans is ~1,00

P_{in1}: Electrical active power at max. efficiency working point

In case of empty cells: ErP non applicable if power < 125W

Curves

Static pressure (p) [Pa]

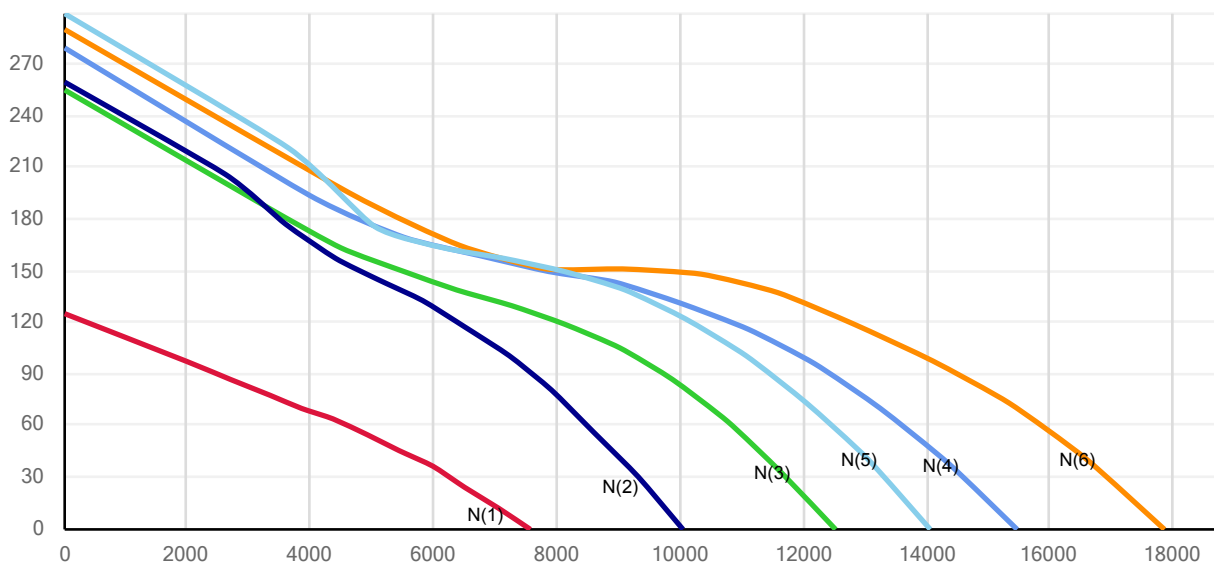

Air flow (Q) [m³/h]

Characteristics

- Axial fan with welded steel casing
- Fan casing, hot dip galvanized after manufacturing
- Asynchronous 3-phased multi-voltage motor 230/400V 50Hz (if <5.5kW) or 400/690V (if >= 5.5kW)
- Impeller with glass-reinforced nylon blades
- Standard cast aluminium hub and IEC central boring, with key way

Drawing and dimensions

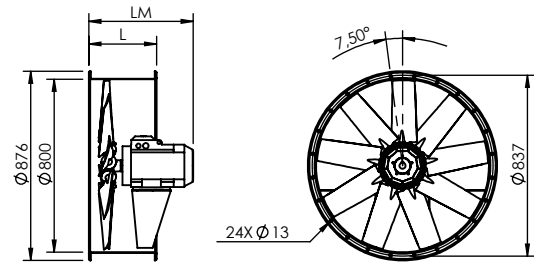

Special configurations

- Dimensions (fan diameter, flanges, casing length, ...) according to customer's requirements
- Stainless steel casing
- ATEX execution for zone 1/21 and/or zone 2/22
- Cast aluminium blades
- Hydraulic motor
- Special executions on demand

Motor, noise and ErP data according to EU 327/2011

Curve N(#)	N-P	Type	Pitch (°)	Power (kW)	Speed (RPM)	IE	L (mm)	LM (mm)	Weight (kg)	eff _o (%)	eff target (%)	P _{in1} (kW)	V _{opt1} (m³/h)	P _{opt1} (Pa)	Article code
1	7-7	P4Z	20	1,50	1435	IE3	314	395	47	40,60	34,50	1,30	10398	210	A1.000.750
2	9-9	P4Z	20	1,50	1435	IE3	314	395	49	44,60	35,10	1,70	8513	348	A1.000.751
3	9-9	P5Z	25	2,20	1450	IE3	314	438	59	43,80	36,10	2,40	13478	313	A1.000.752
4	9-9	P5Z	30	4,00	1445	IE3	314	483	68	42,40	37,00	3,40	18955	306	A1.000.753
7	9-9	P5Z	37,5	5,50	1465	IE3	314	527	105	40,60	38,40	5,50	22782	394	A1.000.754
8	9-9	P5Z	40	5,50	1465	IE3	314	527	105	40,10	38,70	6,20	24588	404	A1.000.754
5	12-12	P5Z	30	5,50	1465	IE3	314	527	106	40,40	38,00	4,90	19782	400	A1.000.756
6	12-12	P5Z	32,5	5,50	1465	IE3	314	527	106	39,00	38,50	5,80	19678	459	A1.000.756

N-P: number of blades - available positions

LM: indicative

eff_o: efficiency on optimal point (aerolic efficiency x motor efficiency)

All data concerning efficiency is given for working without frequency inverter and based on installation mode A - Static

V_{opt}: Volume flow on optimal point

P_{opt}: Pressure on optimal point

The specific ratio for all fans is ~1,00

P_{in}: Electrical active power at max. efficiency working point

In case of empty cells: ErP non applicable if power < 125W

Curves

Static pressure (p) [Pa]

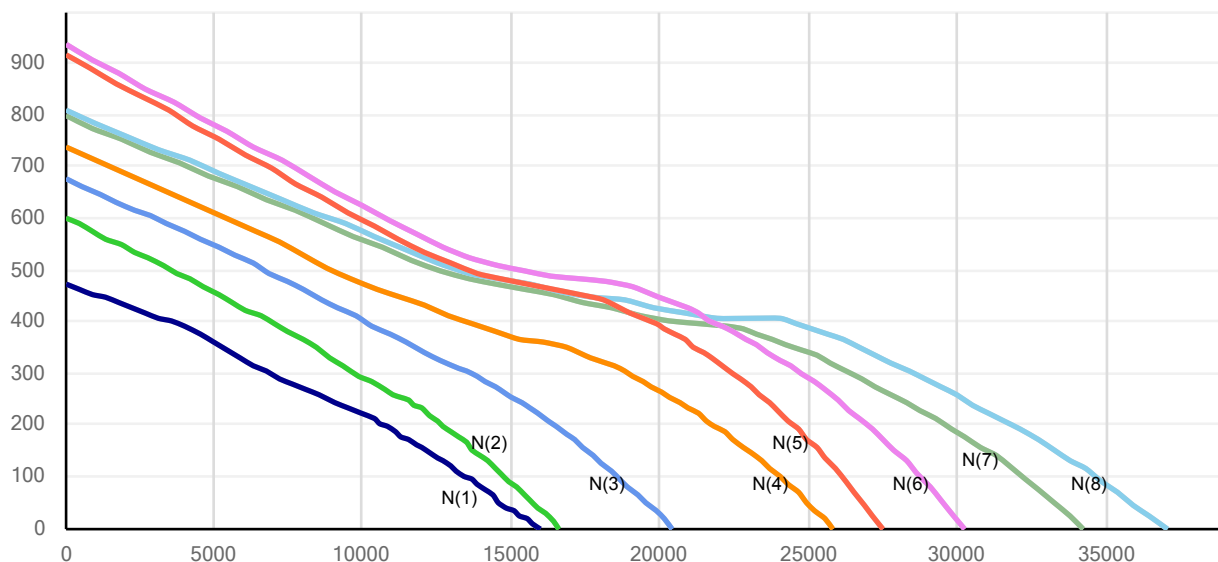

Air flow (Q) [m³/h]

This information can be incorrect due to mistakes and may be changed at any time without prior notice.

Characteristics

- Axial fan with welded steel casing
- Fan casing, hot dip galvanized after manufacturing
- Asynchronous 3-phased multi-voltage motor 230/400V 50Hz (if <5.5kW) or 400/690V (if >= 5.5kW)
- Impeller with glass-reinforced nylon blades
- Standard cast aluminium hub and IEC central boring, with key way

Drawing and dimensions

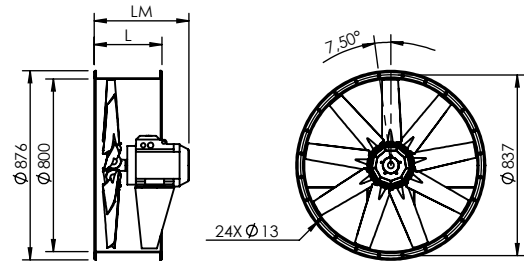

Special configurations

- Dimensions (fan diameter, flanges, casing length, ...) according to customer's requirements
- Stainless steel casing
- ATEX execution for zone 1/21 and/or zone 2/22
- Cast aluminium blades
- Hydraulic motor
- Special executions on demand

Motor, noise and ErP data according to EU 327/2011

Curve N(#)	N-P	Type	Pitch (°)	Power (kW)	Speed (RPM)	IE	L (mm)	LM (mm)	Weight (kg)	eff _s (%)	eff target (%)	P _{in1} (kW)	V _{opt1} (m³/h)	P _{opt1} (Pa)	Article code
1	7-7	P4Z	20	0,37	905	IE2	314	356	39	32,80	27,30	0,40	6558	83	A1.000.757
3	7-7	P5Z	25	0,55	905	IE2	314	356	40	34,50	32,30	0,60	8111	104	A1.000.758
2	9-9	P4Z	20	0,37	905	IE2	314	356	40	36,00	31,90	0,50	5369	138	A1.000.761
4	9-9	P4Z	25	0,55	905	IE2	314	356	41	36,30	32,90	0,80	8978	124	A1.000.762
5	7-7	P5Z	30	0,75	930	IE3	314	370	49	37,50	33,20	0,80	10466	121	A1.000.759
6	7-7	P5Z	32,5	1,10	935	IE3	314	395	51	36,80	33,70	1,00	11617	129	A1.000.760
7	7-7	P5Z	35	1,10	935	IE3	314	395	51	36,30	34,10	1,20	12711	136	A1.000.760
8	7-7	P5Z	37,5	1,10	935	IE3	314	395	51	35,00	34,50	1,40	13751	140	A1.000.760
9	7-7	P5Z	40	1,50	935	IE3	314	438	59	35,00	34,90	1,60	14950	147	A1.000.831
10	9-9	P4Z	40	1,50	945	IE3	314	438	60	36,20	35,30	1,80	16148	165	A1.000.763

N-P: number of blades - available positions

LM: indicative

eff_s: efficiency on optimal point (aerolic efficiency x motor efficiency)

All data concerning efficiency is given for working without frequency inverter and based on installation mode A - Static

V_{opt}: Volume flow on optimal point

P_{opt}: Pressure on optimal point

The specific ratio for all fans is ~1,00

P_{in}: Electrical active power at max. efficiency working point

In case of empty cells: ErP non applicable if power < 125W

Curves

Static pressure (p) [Pa]

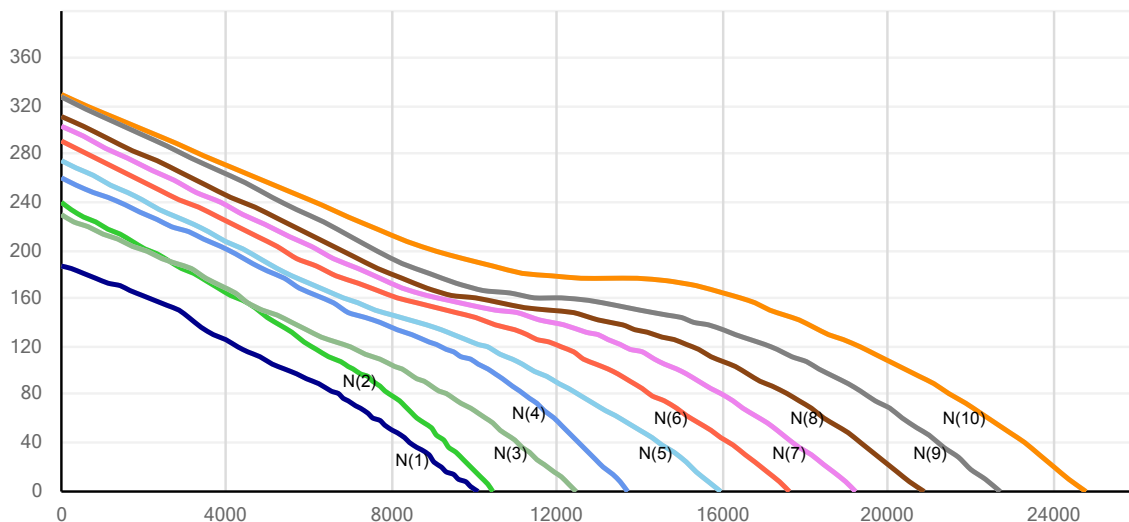

This information can be incorrect due to mistakes and may be changed at any time without prior notice.

Air flow (Q) [m³/h]

Characteristics

- Axial fan with welded steel casing
- Fan casing, hot dip galvanized after manufacturing
- Asynchronous 3-phased multi-voltage motor 230/400V 50Hz (if <5.5kW) or 400/690V (if >= 5.5kW)
- Impeller with glass-reinforced nylon blades
- Standard cast aluminium hub and IEC central boring, with key way

Drawing and dimensions

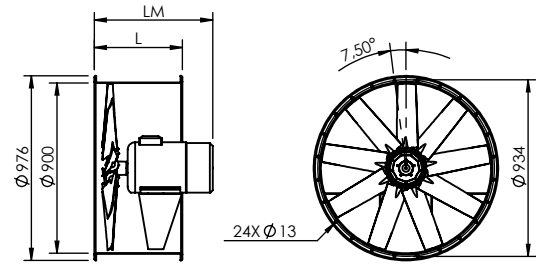

Special configurations

- Dimensions (fan diameter, flanges, casing length, ...) according to customer's requirements
- Stainless steel casing
- ATEX execution for zone 1/21 and/or zone 2/22
- Cast aluminium blades
- Hydraulic motor
- Special executions on demand

Motor, noise and ErP data according to EU 327/2011

Curve N(#)	N-P	Type	Pitch (°)	Power (kW)	Speed (RPM)	IE	L (mm)	LM (mm)	Weight (kg)	eff _o (%)	eff target (%)	P _{in1} (kW)	V _{opt1} (m³/h)	P _{opt1} (Pa)	Article code
1	5-5	P5Z	25	2,20	1450	IE3	314	443	61	45,50	35,40	1,90	14113	245	A1.000.764
2	9-9	P5Z	25	3,00	1445	IE3	314	443	66	43,70	36,80	3,20	17061	326	A1.000.766
3	7-7	P5Z	30	4,00	1445	IE3	314	483	70	43,30	37,40	3,90	18659	364	A1.000.765
4	9-9	P5Z	30	5,50	1465	IE3	465	538	120	44,90	37,90	4,70	24888	343	A1.000.767
5	9-9	P5Z	35	7,50	1465	IE3	465	626	123	43,40	38,90	6,60	27402	420	A1.000.768
6	16-16	P4Z	30	7,50	1465	IE3	465	626	125	40,20	39,40	8,00	18880	677	A1.000.773

N-P: number of blades - available positions

LM: indicative

eff_o: efficiency on optimal point (aerolic efficiency x motor efficiency)

All data concerning efficiency is given for working without frequency inverter and based on installation mode A - Static

V_{opt1}: Volume flow on optimal point

P_{opt1}: Pressure on optimal point

The specific ratio for all fans is ~1,00

P_{in1}: Electrical active power at max. efficiency working point

In case of empty cells: ErP non applicable if power < 125W

Curves

Static pressure (p) [Pa]

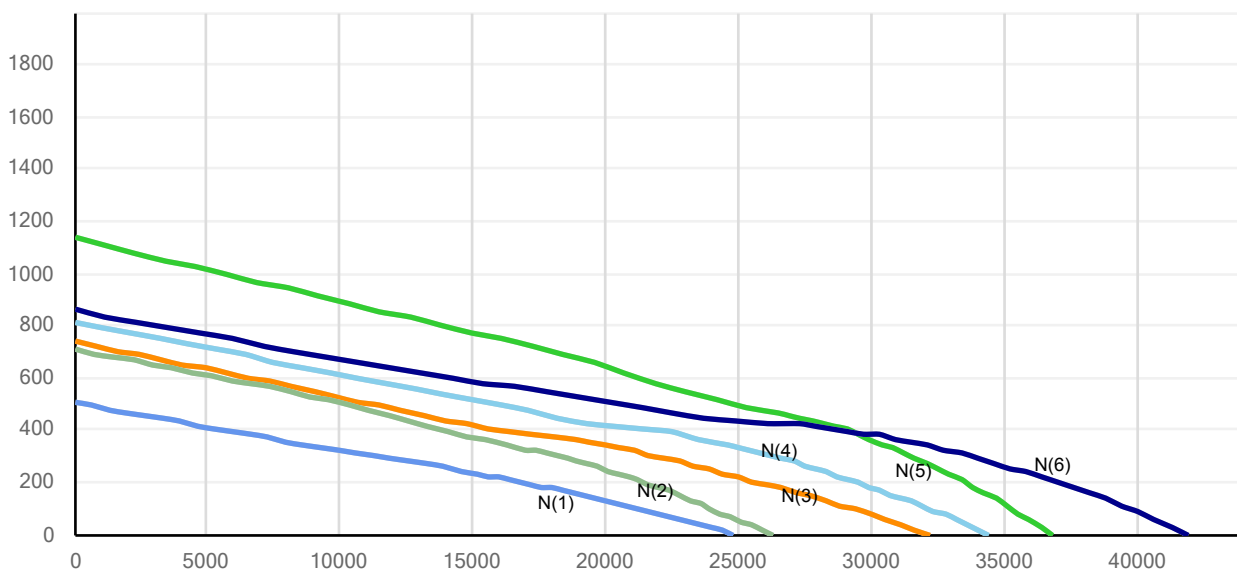

Air flow (Q) [m³/h]

This information can be incorrect due to mistakes and may be changed at any time without prior notice.

Characteristics

- Axial fan with welded steel casing
- Fan casing, hot dip galvanized after manufacturing
- Asynchronous 3-phased multi-voltage motor 230/400V 50Hz (if <5.5kW) or 400/690V (if >= 5.5kW)
- Impeller with glass-reinforced nylon blades
- Standard cast aluminium hub and IEC central boring, with key way

Drawing and dimensions

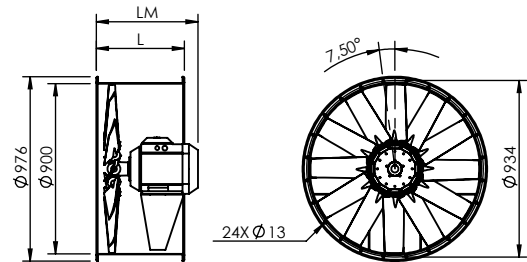

Special configurations

- Dimensions (fan diameter, flanges, casing length, ...) according to customer's requirements
- Stainless steel casing
- ATEX execution for zone 1/21 and/or zone 2/22
- Cast aluminium blades
- Hydraulic motor
- Special executions on demand

Motor, noise and ErP data according to EU 327/2011

Curve N(#)	N-P	Type	Pitch (°)	Power (kW)	Speed (RPM)	IE	L (mm)	LM (mm)	Weight (kg)	eff _o (%)	eff target (%)	P _{in1} (kW)	V _{opt1} (m³/h)	P _{opt1} (Pa)	Article code
1	5-5	P5Z	25	0,55	905	IE2	314	361	45	36,20	32,20	0,60	8809	95	A1.000.774
3	12-12	P4Z	25	1,10	935	IE3	314	406	57	40,00	34,40	1,30	9473	223	A1.000.779
2	9-9	P5Z	25	1,10	935	IE3	314	406	58	39,80	33,50	0,90	11040	137	A1.000.777
4	9-9	P5Z	30	1,50	945	IE3	314	443	64	40,50	34,60	1,40	16054	143	A1.000.778
5	12-12	P4Z	30	1,50	945	IE3	314	443	64	41,40	35,30	1,80	15404	193	A1.000.780
6	12-12	P4Z	32,5	2,20	955	IE3	314	483	72	39,60	35,80	2,20	17304	200	A1.000.781
8	12-12	P4Z	37,5	3,00	960	IE3	465	538	88	36,90	36,60	2,90	20698	209	A1.000.782
7	12-12	P5Z	35	3,00	960	IE3	465	538	90	37,40	36,40	2,70	19022	216	A1.000.783

N-P: number of blades - available positions

LM: indicative

eff_o: efficiency on optimal point (aerolic efficiency x motor efficiency)

All data concerning efficiency is given for working without frequency inverter and based on installation mode A - Static

V_{opt1}: Volume flow on optimal point

P_{opt1}: Pressure on optimal point

The specific ratio for all fans is ~1,00

P_{in1}: Electrical active power at max. efficiency working point

In case of empty cells: ErP non applicable if power < 125W

Curves

Static pressure (p) [Pa]

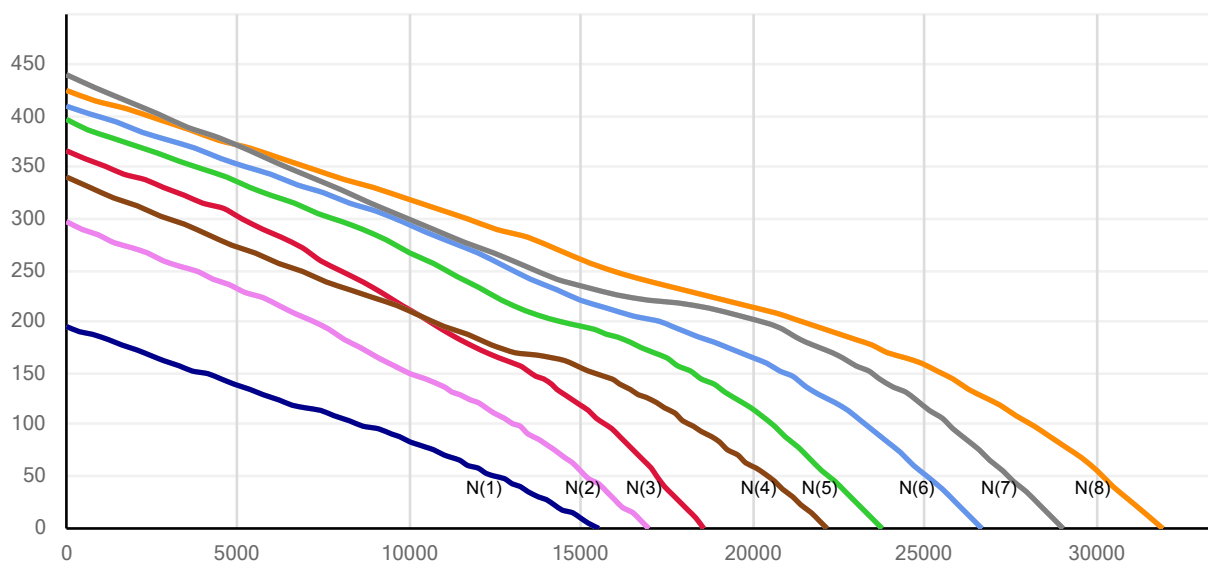

Air flow (Q) [m³/h]

This information can be incorrect due to mistakes and may be changed at any time without prior notice.

Characteristics

- Axial fan with welded steel casing
- Fan casing, hot dip galvanized after manufacturing
- Asynchronous 3-phased multi-voltage motor 230/400V 50Hz (if <5.5kW) or 400/690V (if >= 5.5kW)
- Impeller with glass-reinforced nylon blades
- Standard cast aluminium hub and IEC central boring, with key way

Drawing and dimensions

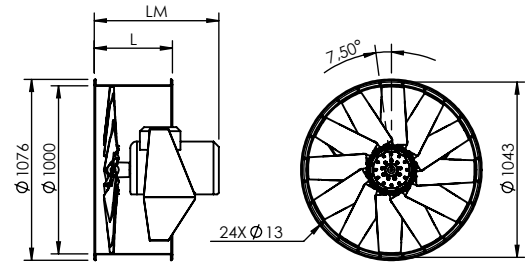

Special configurations

- Dimensions (fan diameter, flanges, casing length, ...) according to customer's requirements
- Stainless steel casing
- ATEX execution for zone 1/21 and/or zone 2/22
- Cast aluminium blades
- Hydraulic motor
- Special executions on demand

Motor, noise and ErP data according to EU 327/2011

Curve N(#)	N-P	Type	Pitch (°)	Power (kW)	Speed (RPM)	IE	L (mm)	LM (mm)	Weight (kg)	eff _o (%)	eff target (%)	P _{in1} (kW)	V _{opt1} (m³/h)	P _{opt1} (Pa)	Article code
1	5-5	P5Z	25	2,20	1450	IE3	314	461	73	42,60	35,70	2,10	13903	253	A1.000.784
2	7-7	P5Z	25	4,00	1445	IE3	314	503	83	43,90	37,10	3,60	20061	312	A1.000.785
3	12-12	P5Z	25	5,50	1465	IE3	465	558	140	42,70	38,40	5,70	25402	385	A1.000.788
4	7-7	P6Z	30	7,50	1465	IE3	465	646	142	46,30	38,80	6,40	27020	438	A1.000.786
5	5-5	P8Y	27	11,00	1477	IE3	465	776	212	46,10	39,70	9,00	31764	522	A1.001.441
6	8-8	P8Y	27	15,00	1477	IE3	465	776	242	45,00	40,20	14,40	34099	760	A1.001.442

N-P: number of blades - available positions

LM: indicative

eff_o: efficiency on optimal point (aerolic efficiency x motor efficiency)

All data concerning efficiency is given for working without frequency inverter and based on installation mode A - Static

V_{opt1}: Volume flow on optimal point

P_{opt1}: Pressure on optimal point

The specific ratio for all fans is ~1,00

P_{in1}: Electrical active power at max. efficiency working point

In case of empty cells: ErP non applicable if power < 125W

Curves

Static pressure (p) [Pa]

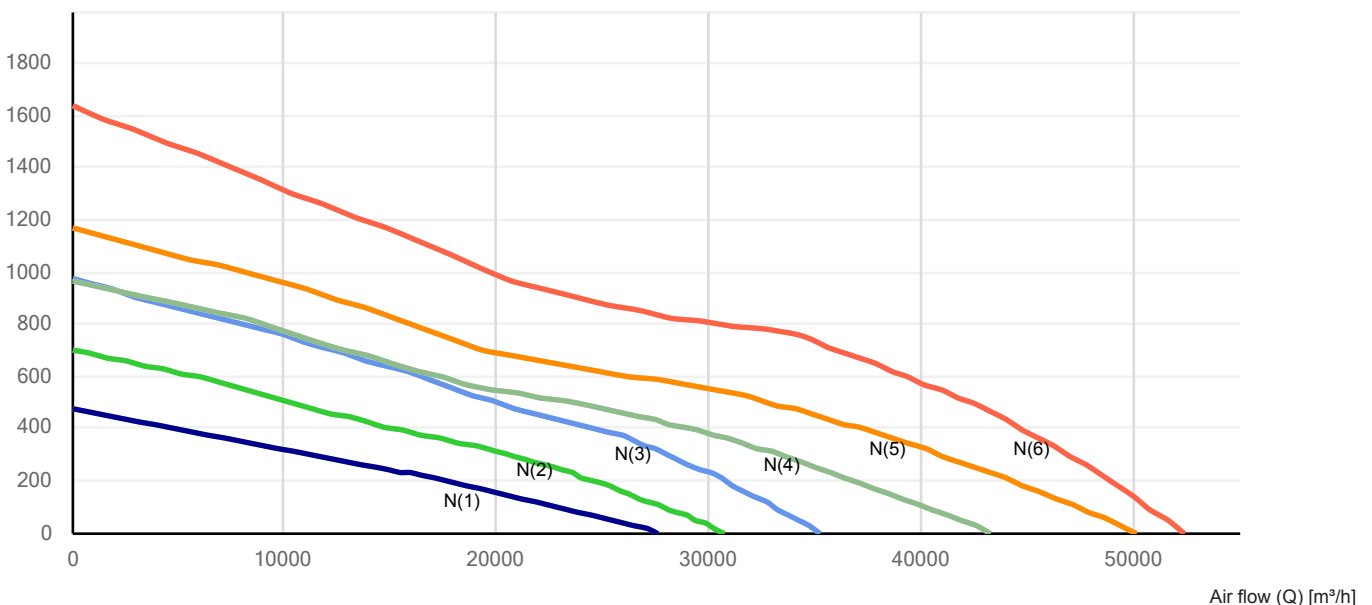

Characteristics

- Axial fan with welded steel casing
- Fan casing, hot dip galvanized after manufacturing
- Asynchronous 3-phased multi-voltage motor 230/400V 50Hz (if <5.5kW) or 400/690V (if >= 5.5kW)
- Impeller with glass-reinforced nylon blades
- Standard cast aluminium hub and IEC central boring, with key way

Drawing and dimensions

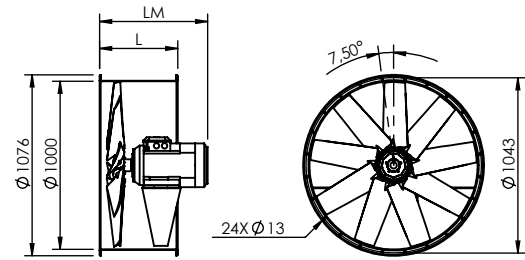

Special configurations

- Dimensions (fan diameter, flanges, casing length, ...) according to customer's requirements
- Stainless steel casing
- ATEX execution for zone 1/21 and/or zone 2/22
- Cast aluminium blades
- Hydraulic motor
- Special executions on demand

Motor, noise and ErP data according to EU 327/2011

Curve N(#)	N-P	Type	Pitch (°)	Power (kW)	Speed (RPM)	IE	L (mm)	LM (mm)	Weight (kg)	eff _o (%)	eff target (%)	P _{in1} (kW)	V _{opt1} (m³/h)	P _{opt1} (Pa)	Article code
1	5-5	P5Z	25	0,55	905	IE2	314	396	57	33,90	32,40	0,60	8678	99	A1.000.792
2	5-5	P5Z	30	1,10	935	IE3	314	431	67	39,90	33,70	1,00	13590	117	A1.000.793
3	7-7	P5Z	30	1,50	945	IE3	314	461	75	40,20	35,10	1,70	15335	175	A1.000.795
4	9-9	P5Z	30	2,20	955	IE3	314	503	85	40,90	35,70	2,10	18778	186	A1.000.796
5	12-12	P5Z	30	3,00	960	IE3	465	558	109	39,30	36,30	2,60	21508	191	A1.000.799
6	9-9	P6Z	32,5	3,00	960	IE3	465	558	110	40,80	36,90	3,30	21712	246	A1.000.797
7	9-9	P6Z	35	4,00	975	IE3	465	644	125	41,40	37,30	3,80	24293	259	A1.000.798
8	9-9	P6Z	37,5	4,00	975	IE3	465	644	125	39,30	37,80	4,60	27766	260	A1.000.798

N-P: number of blades - available positions

LM: indicative

eff_o: efficiency on optimal point (aerolic efficiency x motor efficiency)

All data concerning efficiency is given for working without frequency inverter and based on installation mode A - Static

V_{opt}: Volume flow on optimal point

P_{opt}: Pressure on optimal point

The specific ratio for all fans is ~1,00

P_{in}: Electrical active power at max. efficiency working point

In case of empty cells: ErP non applicable if power < 125W

Curves

Static pressure (p) [Pa]

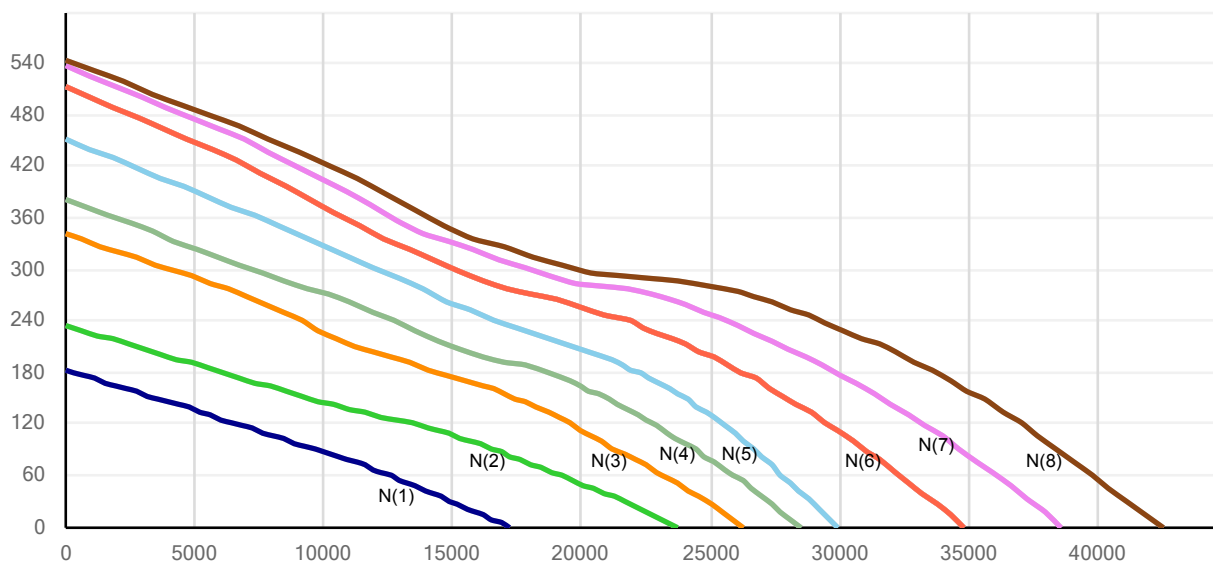

Air flow (Q) [m³/h]

This information can be incorrect due to mistakes and may be changed at any time without prior notice.

Characteristics

- Axial fan with welded steel casing
- Fan casing, hot dip galvanized after manufacturing
- Asynchronous 3-phased multi-voltage motor 230/400V 50Hz (if <5.5kW) or 400/690V (if >= 5.5kW)
- Impeller with glass-reinforced nylon blades
- Standard cast aluminium hub and IEC central boring, with key way

Drawing and dimensions

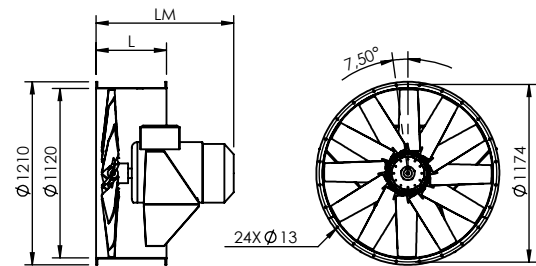

Special configurations

- Dimensions (fan diameter, flanges, casing length, ...) according to customer's requirements
- Stainless steel casing
- ATEX execution for zone 1/21 and/or zone 2/22
- Cast aluminium blades
- Hydraulic motor
- Special executions on demand

Motor, noise and ErP data according to EU 327/2011

Curve N(#)	N-P	Type	Pitch (°)	Power (kW)	Speed (RPM)	IE	L (mm)	LM (mm)	Weight (kg)	eff _o (%)	eff target (%)	P _{in1} (kW)	V _{opt1} (m³/h)	P _{opt1} (Pa)	Article code
1	12-12	P5Z	25	7,50	1465	IE3	465	648	148	42,50	39,20	7,50	28309	450	A1.001.443
2	5-5	P7T	25	11,00	1477	IE3	465	766	217	42,90	40,00	11,60	35468	563	A1.001.444
3	5-5	P7T	30	15,00	1477	IE3	465	766	242	44,10	40,30	15,50	44071	623	A1.001.445

N-P: number of blades - available positions

LM: indicative

eff_o: efficiency on optimal point (aerolic efficiency x motor efficiency)

All data concerning efficiency is given for working without frequency inverter and based on installation mode A - Static

V_{opt}: Volume flow on optimal point

P_{opt}: Pressure on optimal point

The specific ratio for all fans is ~1,00

P_{in1}: Electrical active power at max. efficiency working point

In case of empty cells: ErP non applicable if power < 125W

Curves

Static pressure (p) [Pa]

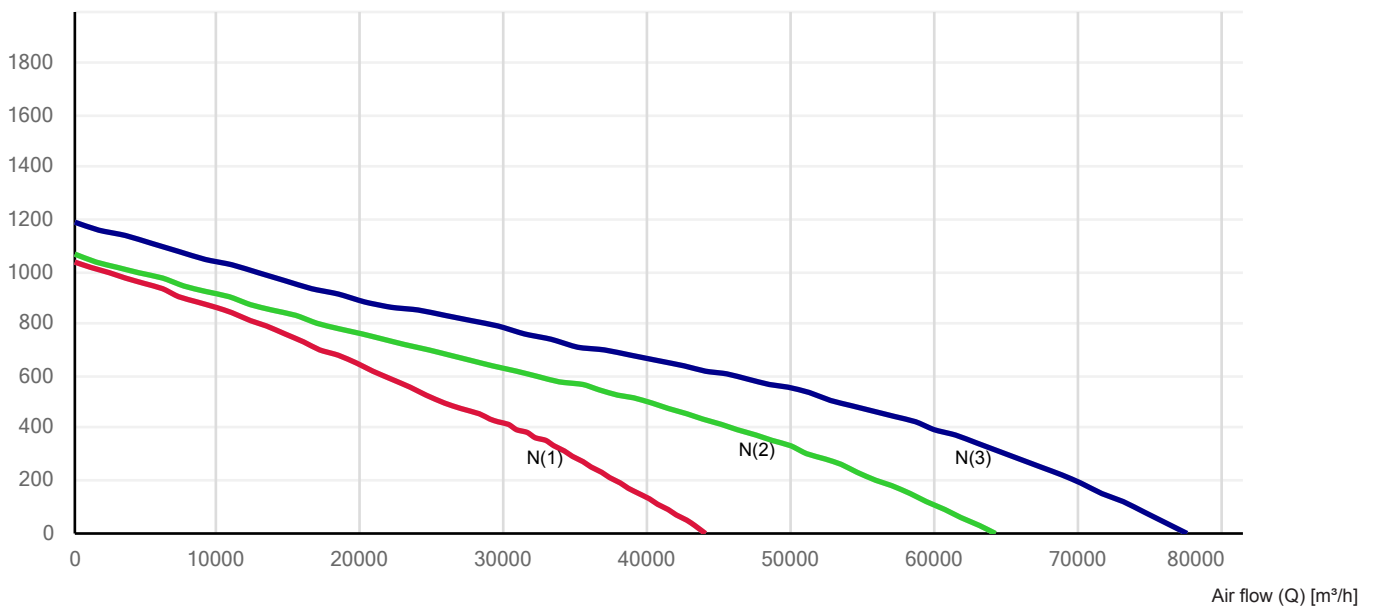

Characteristics

- Axial fan with welded steel casing
- Fan casing, hot dip galvanized after manufacturing
- Asynchronous 3-phased multi-voltage motor 230/400V 50Hz (if <5.5kW) or 400/690V (if >= 5.5kW)
- Impeller with glass-reinforced nylon blades
- Standard cast aluminium hub and IEC central boring, with key way

Drawing and dimensions

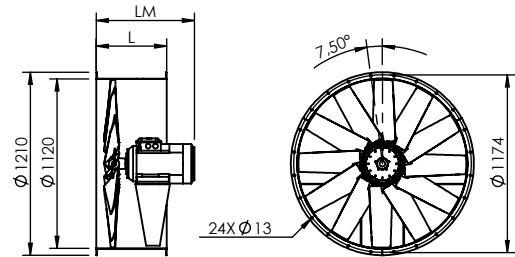

Special configurations

- Dimensions (fan diameter, flanges, casing length, ...) according to customer's requirements
- Stainless steel casing
- ATEX execution for zone 1/21 and/or zone 2/22
- Cast aluminium blades
- Hydraulic motor
- Special executions on demand

Motor, noise and ErP data according to EU 327/2011

Curve N(#)	N-P	Type	Pitch (°)	Power (kW)	Speed (RPM)	IE	L (mm)	LM (mm)	Weight (kg)	eff _e (%)	eff target (%)	P _{in1} (kW)	V _{opt1} (m³/h)	P _{opt1} (Pa)	Article code
1	5-5	P6Z	25	1,50	945	IE3	465	465	87	44,60	34,70	1,50	17524	148	A1.000.807
3	7-7	P6Z	30	2,20	955	IE3	465	503	97	42,70	36,20	2,50	21739	199	A1.000.808
2	9-9	P6Z	25	2,20	955	IE3	465	503	99	45,70	36,10	2,40	19829	221	A1.000.810
4	7-7	P6Z	32,5	3,00	960	IE3	465	562	108	43,90	36,70	3,00	25393	210	A1.000.809
5	9-9	P6Z	30	4,00	975	IE3	465	648	126	46,20	37,30	3,70	27838	247	A1.000.811
6	9-9	P6Z	32,5	4,00	975	IE3	465	648	126	44,50	37,70	4,40	31166	251	A1.000.811
7	12-12	P6Z	32,5	5,50	965	IE3	465	648	160	42,90	38,40	5,60	31180	309	A1.000.812
8	8-8	P8Y	30	7,50	975	IE3	465	766	205	43,80	39,10	7,30	35878	359	A1.001.446
9	8-8	P8Y	33	11,00	975	IE3	465	766	246	43,30	39,50	8,50	39612	370	A1.001.447
10	8-8	P8Y	36	11,00	975	IE3	465	766	246	40,10	39,90	10,20	41775	391	A1.001.447

N-P: number of blades - available positions

LM: indicative

eff_e: efficiency on optimal point (aerolic efficiency x motor efficiency)

All data concerning efficiency is given for working without frequency inverter and based on installation mode A - Static

V_{opt1}: Volume flow on optimal point

P_{opt1}: Pressure on optimal point

The specific ratio for all fans is ~1,00

P_{in1}: Electrical active power at max. efficiency working point

In case of empty cells: ErP non applicable if power < 125W

Curves

Static pressure (p) [Pa]

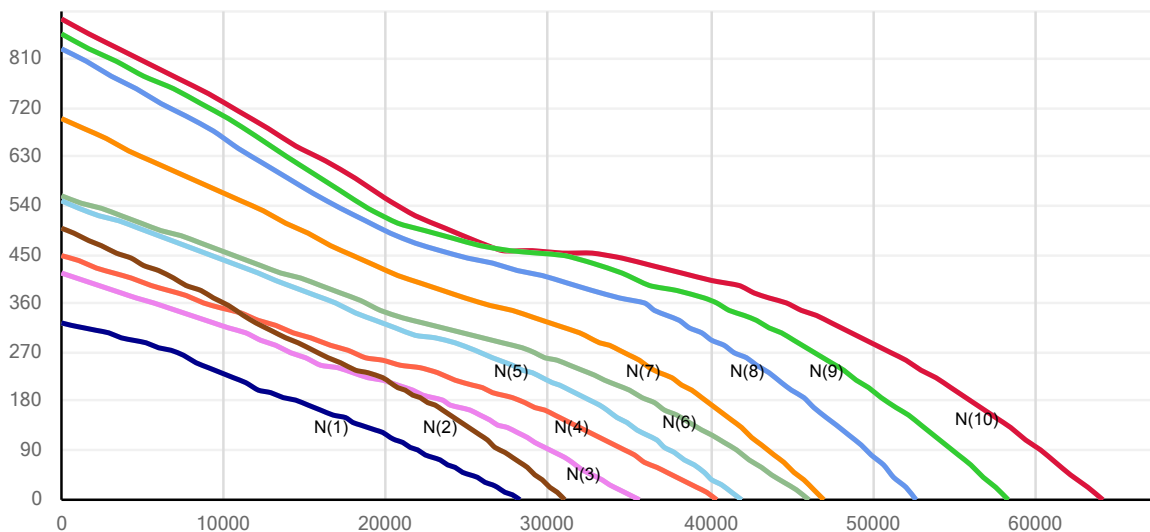

This information can be incorrect due to mistakes and may be changed at any time without prior notice.

Air flow (Q) [m³/h]

Characteristics

- Axial fan with welded steel casing
- Fan casing, hot dip galvanized after manufacturing
- Asynchronous 3-phased multi-voltage motor 230/400V 50Hz (if <5.5kW) or 400/690V (if >= 5.5kW)
- Impeller with glass-reinforced nylon blades
- Standard cast aluminium hub and IEC central boring, with key way

Drawing and dimensions

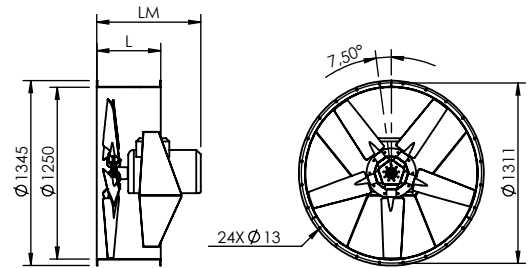

Special configurations

- Dimensions (fan diameter, flanges, casing length, ...) according to customer's requirements
- Stainless steel casing
- ATEX execution for zone 1/21 and/or zone 2/22
- Cast aluminium blades
- Hydraulic motor
- Special executions on demand

Motor, noise and ErP data according to EU 327/2011

Curve N(#)	N-P	Type	Pitch (°)	Power (kW)	Speed (RPM)	IE	L (mm)	LM (mm)	Weight (kg)	eff _s (%)	eff target (%)	P _{in1} (kW)	V _{opt1} (m³/h)	P _{opt1} (Pa)	Article code
1	5-5	P7T	20	2,20	955	IE3	465	533	109	39,90	36,20	2,50	20469	197	A1.000.815
3	5-5	P7T	25	4,00	975	IE3	465	654	136	40,70	37,60	4,10	27242	248	A1.000.816
2	7-7	P7T	20	4,00	975	IE3	465	654	140	40,00	37,30	3,70	22248	267	A1.000.819
5	5-5	P7T	30	5,50	965	IE3	465	654	141	42,30	38,40	5,60	33242	284	A1.000.817
4	7-7	P7T	25	5,50	965	IE3	465	654	145	39,10	38,50	5,80	28767	315	A1.000.820
6	7-7	P7T	30	7,50	975	IE3	465	756	214	42,40	39,40	8,00	35881	376	A1.000.821
7	7-7	P7T	35	11,00	975	IE3	465	756	255	40,00	40,00	10,60	42276	400	A1.000.822

N-P: number of blades - available positions

LM: indicative

eff_s: efficiency on optimal point (aerolic efficiency x motor efficiency)

All data concerning efficiency is given for working without frequency inverter and based on installation mode A - Static

V_{opt}: Volume flow on optimal point

P_{opt}: Pressure on optimal point

The specific ratio for all fans is ~1,00

P_{in}: Electrical active power at max. efficiency working point

In case of empty cells: ErP non applicable if power < 125W

Curves

Static pressure (p) [Pa]

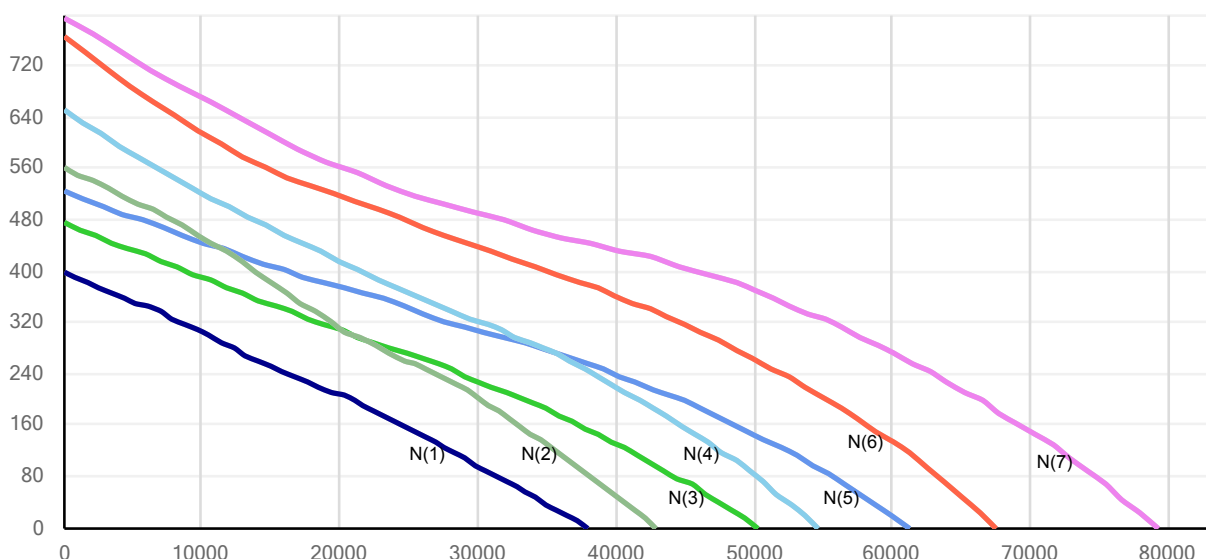

Air flow (Q) [m³/h]

This information can be incorrect due to mistakes and may be changed at any time without prior notice.

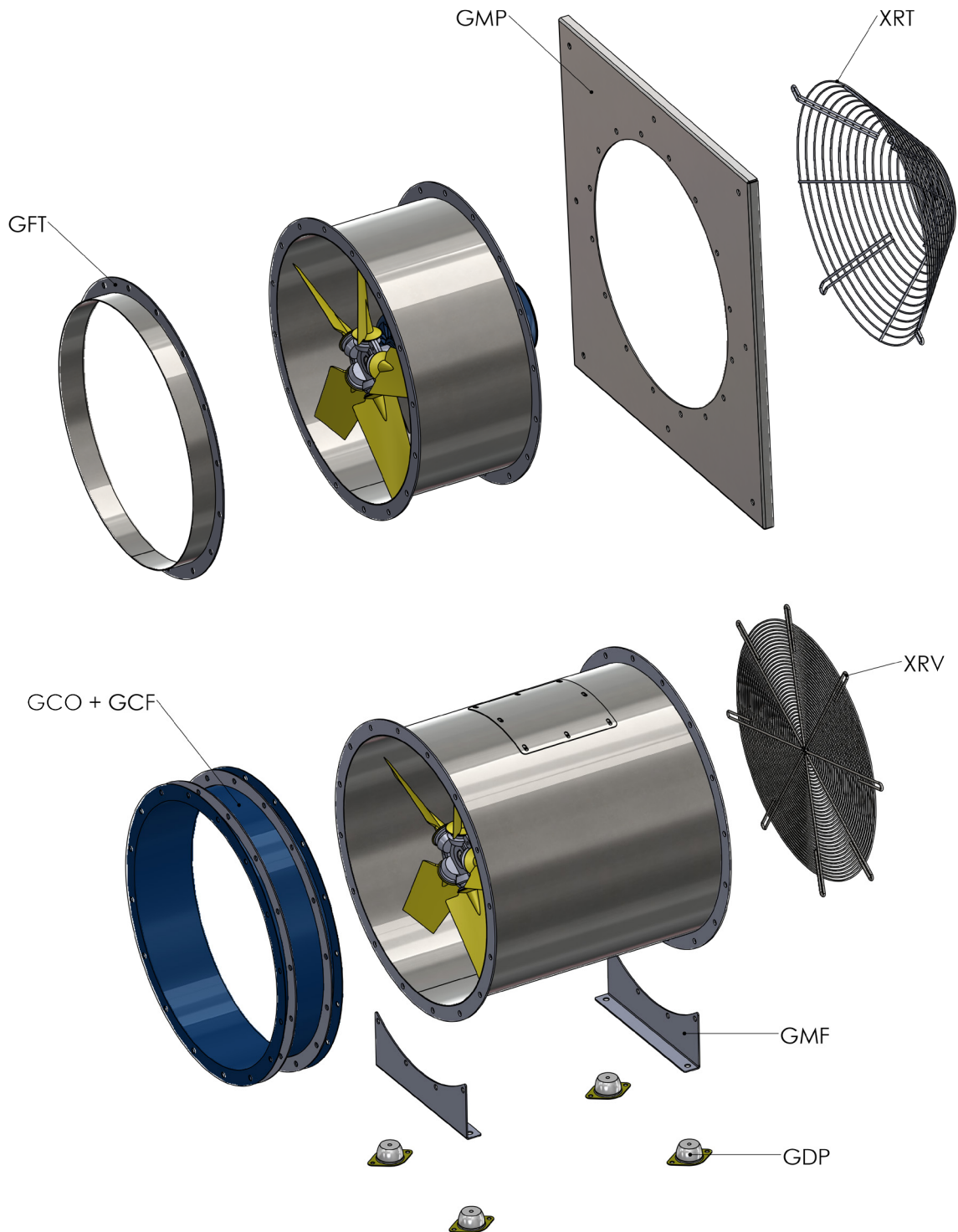

ADL	Long casing
GCF	Counter flange
GCO	Flexible + counter flange
GDP Type C	Anti-vibration mounts
GDP Type M	Anti-vibration mounts

GMF AD	Mounting feet
GMP	Square mounting plate
GFT	Flat take-off
XRT	Trapezoidal wire guard
XRV	Flat wire guard

ADL - Long casing

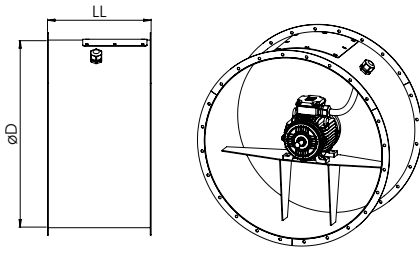

- Long casing
- Includes an inspection door located above the motor terminal box
- Includes a cable duct (steel / PVC, -25°C / +100°C) + external (brass) cable gland

Type		MOTOR						
		63	71	80	90S&L	100	112	132S&M
355	kg	18	21	27	33			
	LL	350	350	400	450			
400	kg	20	23	29	36	47		
	LL	350	350	400	450	500		
450	kg	22	25	32	39	51	64	
	LL	350	350	400	450	500	550	
500	kg		29	34	41	53	65	
	LL		400	400	450	500	500	
560	kg			38	44	57	69	103
	LL			400	450	500	500	650
630	kg			43	48	62	74	108
	LL			450	450	500	500	650

Type		MOTOR						
		90S&L	100	112	132S&M	160M&L	180M&L	200M&L
710	kg	60	75	88	125			
	LL	450	500	500	650			
800	kg	65	81	94	133			
	LL	450	500	500	650			
900	kg		87	101	141	197		
	LL		500	500	650	800		
1000	kg			110	155	209	315	382
	LL			500	650	800	900	950
1120	kg				170	226	337	407
	LL				650	800	900	950
1250	kg				185	244	360	432
	LL				650	800	900	950

GCF - Counter flange

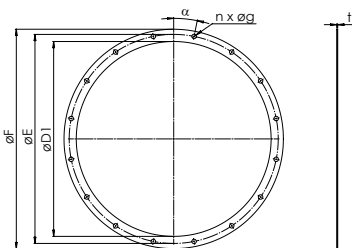

- Material: galvanized - upon request: unprotected steel, stainless steel
- Note: welding flange upon request

Type	Item	ø D1	ø E	ø F	n x ø g	t
GCF 315	C1.000.235	319	356	379	8 x ø 11	2
GCF 355	C1.000.237	359	395	419	8 x ø 11	2
GCF 400	C1.000.239	405	438	465	12 x ø 11	2
GCF 450	C1.000.241	455	487	515	12 x ø 11	2
GCF 500	C1.000.243	505	541	565	12 x ø 11	2
GCF 560	C1.000.245	565	605	635	16 x ø 13	2
GCF 630	C1.000.249	636	674	706	16 x ø 13	3
GCF 710	C1.000.251	716	751	786	16 x ø 13	3
GCF 800	C1.000.253	806	837	876	24 x ø 13	3
GCF 900	C1.000.255	906	934	976	24 x ø 13	3
GCF 1000	C1.000.257	1006	1043	1076	24 x ø 13	3
GCF 1120	C1.000.259	1126	1174	1210	24 x ø 13	3
GCF 1250	C1.000.261	1256	1311	1345	24 x ø 13	3

GCO - Flexible + counter flange

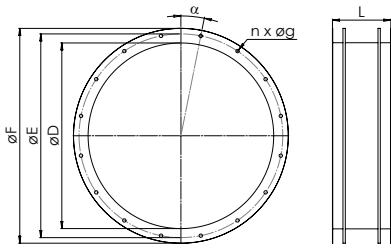

- Flanged flexible connection between fan and ducting system
- Assembly with counter flanges (included)
- Type L: Polyester fiber + PVC coating (670 gr/ m², -35°C / +80°C, blue)
- Type H: Polyester fiber + PVC coating (950 gr/ m², -35°C / +80 °C, black)
- Type A: Anti-static + PVC coating (1200 gr/ m², -35°C / +80 °C, grey)

Type	Item	ø D1	ø E	ø F	n x ø g	L
GCO 315	A1.000.676	315	356	379	8 x ø 11	150
GCO 355	A1.000.677	355	395	419	8 x ø 11	150
GCO 400	A1.001.002	400	438	465	12 x ø 11	150
GCO 450	A1.000.679	450	487	515	12 x ø 11	150
GCO 500	A1.000.624	500	541	565	12 x ø 11	150
GCO 560	A1.000.681	560	605	635	16 x ø 11	150
GCO 630	A1.000.683	630	674	706	16 x ø 13	150
GCO 710	A1.000.684	710	751	786	16 x ø 13	150
GCO 800	A1.000.685	800	837	876	24 x ø 13	150
GCO 900	A1.000.686	900	934	976	24 x ø 13	150
GCO 1000	A1.000.687	1000	1043	1076	24 x ø 13	150
GCO 1120	A1.000.688	1120	1174	1210	24 x ø 13	150
GCO 1250	A1.000.689	1250	1311	1345	24 x ø 13	150

GDP Type C - Anti-vibration mount

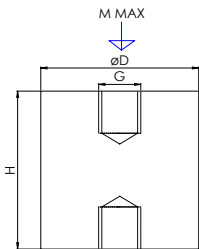

- Anti-vibration mounts in compression mode
- Low frequency vibration insulation in all directions
- 2 fixing points

Type	M - Max (kg) 60° IRH	H	G
GDP C 15/15	11	15	M 4
GDP C 20/25	19,5	25	M 6
GDP C 30/30	44,5	30	M 8
GDP C 40/30	84,5	30	M 8

GDP Type M - Anti-vibration mount

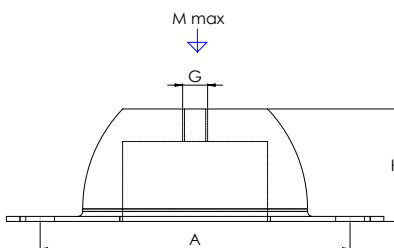

- Anti-vibration mounts in compression mode
- Low frequency vibration insulation in all directions
- 3 fixing points

Type	M - Max (kg) 40° IRH	M - Max (kg) 60° IRH	A	H	G
GDP M 7	3,5	9	50	20	M 6
GDP M 25	20	50	66	25	M 8
GDP M 50	40	80	92	35	M 10
GDP M 100	70	150	110	40	M 10
GDP M 200	130	220	124	45	M 10

GMF AD - Mounting feet

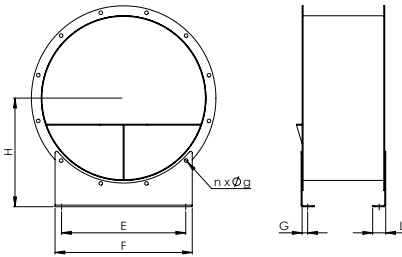

- Mounting feet compatible with ADK/ AVK design - set of 2 mounting feet
- Material: galvanized - upon request: stainless steel
- Note: If the center of gravity is off-centered, risk of tipping
- For larger fans: on demand

Type	Item	E	F	L	G	H	n x Øg
GMF 315	A1.000.718	160	200	40	17	237,5	8 x Ø 11
GMF 355	A1.000.719	160	200	40	17	259,5	8 x Ø 11
GMF 400	A1.000.720	290	330	40	17	282,5	12 x Ø 11
GMF 450	A1.000.721	340	380	40	17	307,5	12 x Ø 11
GMF 500	A1.000.722	380	420	40	17	332,5	12 x Ø 11
GMF 560	A1.000.723	340	380	40	17	367,5	16 x Ø 13
GMF 630	A1.000.725	360	400	40	17	403	16 x Ø 13
GMF 710	A1.000.726	460	500	40	16	443	16 x Ø 13

GMP - Square mounting plate

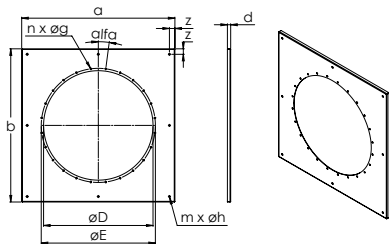

- Square mounting plate compatible with ADK and AVK fans
- Material: galvanized - upon request: stainless steel

Type	Item	a	b	d	øD	øE	n	øg	α	z	m	øh
GMP 31A	C1.000.211	500	500	15	315	356	8	11	22,5	50	4	14,5
GMP 35A	C1.000.213	600	600	20	355	395	8	11	22,5	50	4	14,5
GMP 40A	C1.000.215	650	650	20	400	438	12	12	15	50	4	14,5
GMP 45A	C1.000.217	700	700	20	450	487	12	12	15	50	8	14,5
GMP 50A	C1.000.219	750	750	20	500	541	12	12	15	50	8	14,5
GMP 56A	C1.000.221	800	800	20	560	605	16	14	11,25	50	8	14,5
GMP 63A	C1.000.223	900	900	25	630	674	16	14	11,25	50	8	14,5
GMP 71A	C1.000.225	1000	1000	25	710	751	16	14	11,25	50	12	14,5
GMP 80A	C1.000.227	1150	1150	25	800	844	24	14	7,5	50	12	16,5
GMP 90A	C1.000.229	1250	1250	30	900	934	24	14	7,5	50	12	16,5
GMP 10A	C1.000.231	1400	1400	30	1000	1043	24	14	7,5	50	12	16,5

GFT - Flat take off

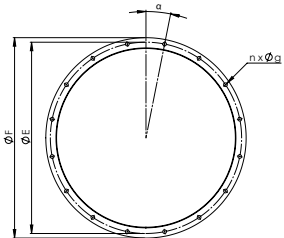

- Take off for flexible connection/ duct
- Material: galvanized - upon request: stainless steel

Type	Item	øD1	øE	øF	n x Øg	L
GFT 315	A1.000.689	319	356	379	8 x Ø 11	60
GFT 355	A1.000.691	359	395	419	8 x Ø 11	60
GFT 400	A1.000.693	404	438	465	12 x Ø 11	60
GFT 450	A1.000.695	454	487	515	12 x Ø 11	60
GFT 500	A1.000.697	504	541	565	12 x Ø 11	60
GFT 560	A1.000.699	564	605	635	16 x Ø 13	60
GFT 630	A1.000.703	634	674	706	16 x Ø 13	60
GFT 710	A1.000.705	714	751	786	16 x Ø 13	60
GFT 800	A1.000.707	806	837	876	24 x Ø 13	60
GFT 900	A1.000.709	906	934	976	24 x Ø 13	60
GFT 1000	A1.000.711	1003	1043	1076	24 x Ø 13	60
GFT 1120	A1.000.713	1126	1174	1210	24 x Ø 13	60
GFT 1250	A1.000.715	1256	1311	1345	24 x Ø 13	60

XRT - Trapezoidal wire guard

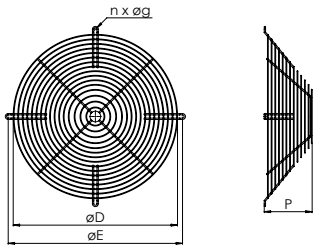

- Trapezoidal wire guard
- ADK / AVK: motor side assembly
- Material: stainless steel
- Design in accordance with the ISO 13857 norm

Type	Item	ø D	ø E	n x ø g	P
XRT 315	C1.000.114	400	357	4 x ø 12	90
XRT 355	C1.000.115	315	396	4 x ø 12	90
XRT 400	C1.000.116	400	438	4 x ø 12	110
XRT 450	C1.000.117	450	488	4 x ø 12	130
XRT 500	C1.000.118	500	536	4 x ø 12	130
XRT 560	C1.000.119	560	608	4 x ø 12	180
XRT 630	C1.000.120	630	682	4 x ø 12	200
XRT 710	C1.000.121	710	760	4 x ø 14	200
XRT 800	C1.000.122	800	842	4 x ø 14	200
XRT 900	C1.000.123	900	935	4 x ø 14	250
XRT 1000	C1.000.124	1000	1051	8 x ø 14	250
XRT 1120	C1.000.125	1120	1176	8 x ø 14	300
XRT 1250	C1.000.126	1250	1311	8 x ø 14	300

XRV - Flat wire guard

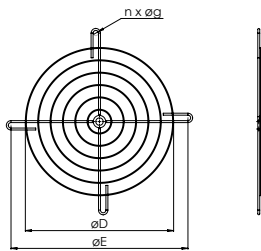

- Flat wire guard
- ADK / AVK: impeller side assembly
- Material: stainless steel
- Design in accordance with the ISO 13857 norm

Type	Item	ø D	ø E	n x ø g
XRV 315	C1.000.128	400	357	4 x ø 11
XRV 355	C1.000.129	315	396	4 x ø 11
XRV 400	C1.000.130	400	438	4 x ø 11
XRV 450	C1.000.131	450	488	4 x ø 11
XRV 500	C1.000.132	500	536	4 x ø 11
XRV 560	C1.000.133	560	608	4 x ø 11
XRV 630	C1.000.134	630	682	8 x ø 13
XRV 710	C1.000.135	710	760	8 x ø 13
XRV 800	C1.000.136	800	842	8 x ø 13
XRV 900	C1.000.137	900	935	8 x ø 13
XRV 1000	C1.000.138	1000	1051	8 x ø 13
XRV 1120	C1.000.139	1120	1176	8 x ø 13
XRV 1250	C1.000.140	1250	1311	8 x ø 13